

# Active Load Pull

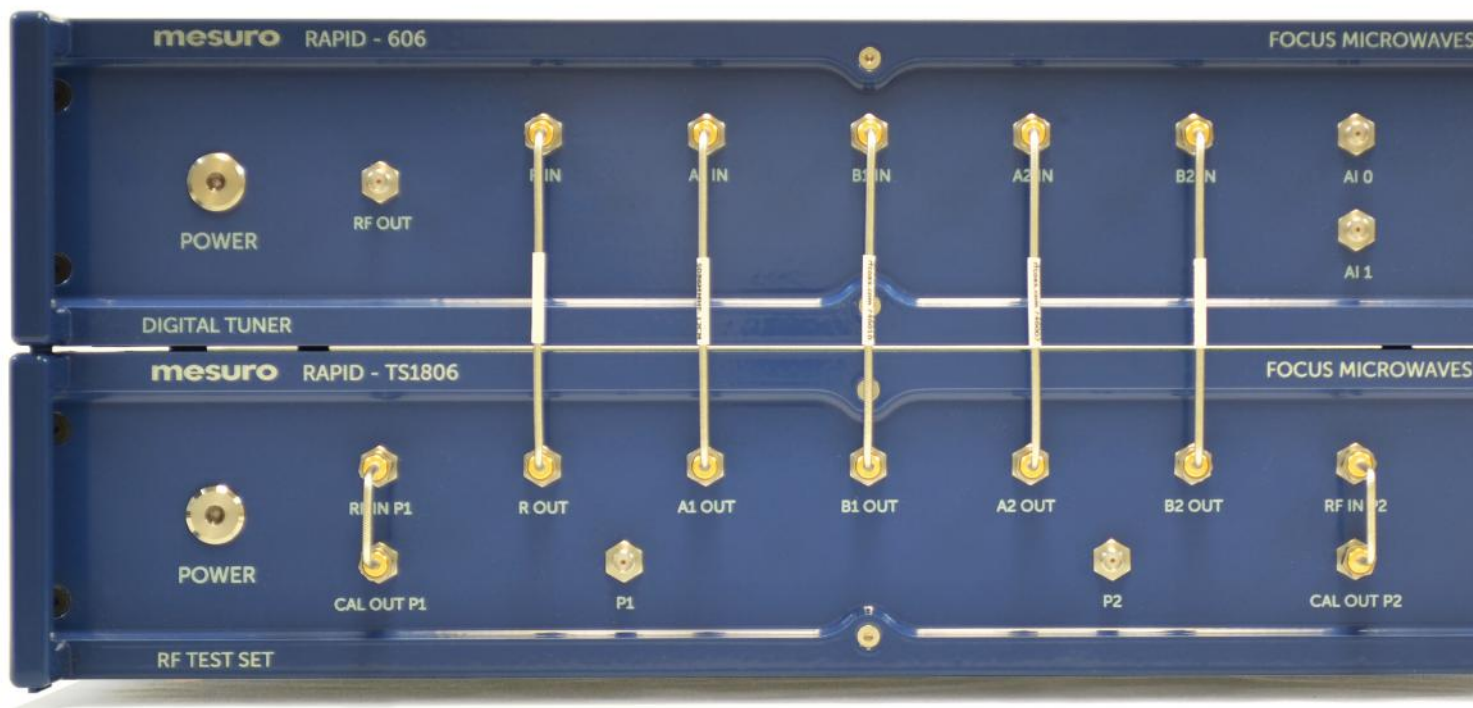

RAPID - active tuning made easy -  
A modular approach to a complex problem

# RAPID Active Tuner

Focus Microwaves' RAPID digital tuner is the heart of a precision, high-speed, load pull device characterization system. The RAPID has been developed by Focus' UK subsidiary MESURO and is suitable for every phase of the design and production test cycle. This series of new digital tuner products provide performance, reliability, and cutting edge features for a reasonable cost.

The RAPID series is compatible with the hardware and software of existing labs, thereby allowing users to easily upgrade their existing systems.

*RAPID uses exclusively our proprietary technology, protected by the following patents:*

 US Patent 7,816,926       EU Patent 1649297B1

The RAPID can be used as a standalone impedance synthesis and measurement system, or combined into a hybrid solution when paired with Focus' MPT series harmonic tuners. The passive tuners can be used to synthesize fixed harmonic impedances in a high speed fundamental active setup. With this modular configuration the user benefits from speed, increased tuning range for F0, CW, pulsed and modulated signals while reducing cost and simplifying the system.

*RAPID employs CCMT & MPT prematching technology, protected by the following patents:*

 9,459,336       9,213,056       8,497,689

## RAPID Setup Diagram

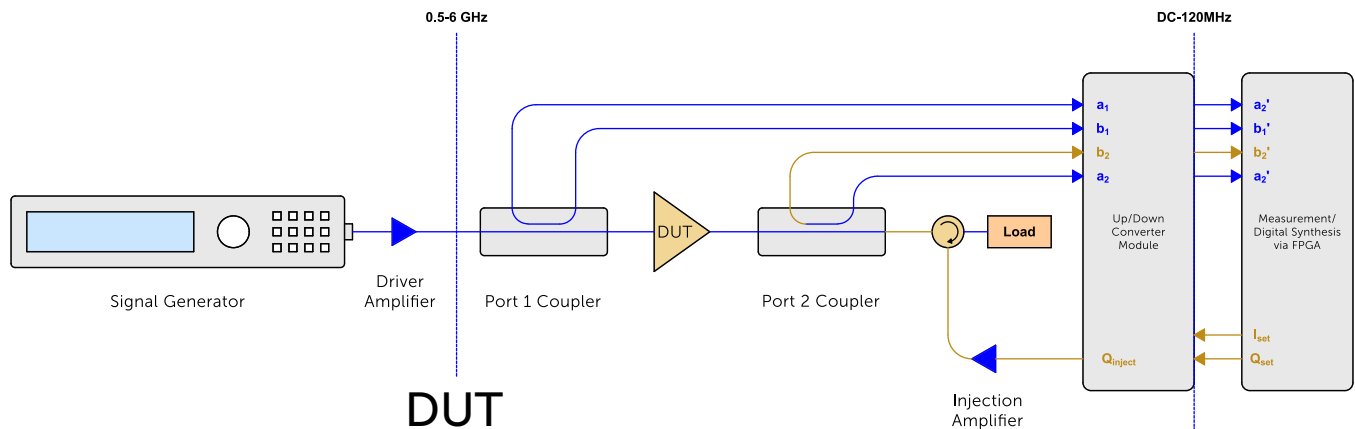

## Key Benefits

- Dramatical improvement of Test-Bench Throughput. Ultra-fast impedance control and measurement (up to 50 tuning & measurement events/second including DC).
- Modular Architecture designed for scalability. The innovative modular approach allows the user to re-use existing test equipment and add more functionality in the future.
- Improved Modulated Measurement Capability. 100MHz real time bandwidth with wideband impedance control and/or circuit emulation. Ability to de-skew non-ideal tuner impedance over bandwidth.
- Reduced testing cost. RAPID does not require an external VNA for calibration or measurement. It performs realtime s-parameter, power, vector and spectral mea-

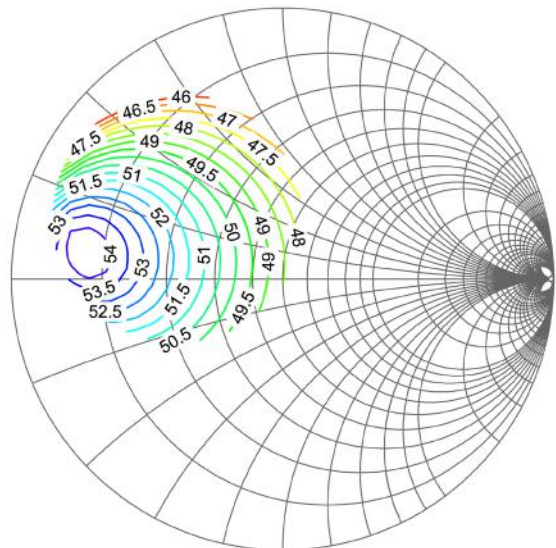

## Fast CW Impedance Tuning

Load pull can now be performed in just seconds. RAPID's open loop architecture and FPGA algorithms allow for real-time tuning. The speed of a CW load pull is approximately: 5 ms per load synthesized at 1KHz IFBW (200 points/second). This includes impedance synthesis and output power measurement.

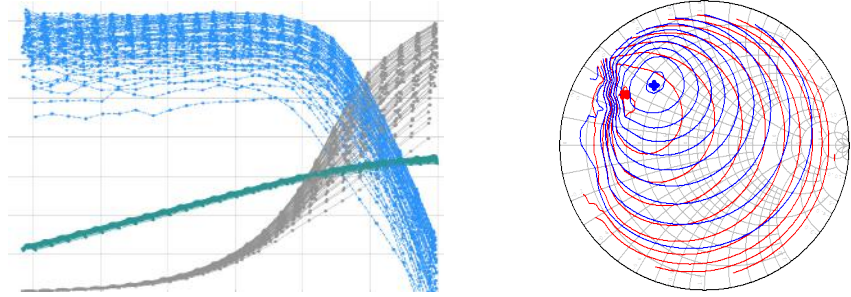

## WideBand Impedance Tuning

As communication standards require more and more channel bandwidth the need for wideband tuning is increasing. Wideband impedance tuning is now possible as RAPID's active loop has 100MHz of instantaneous bandwidth allowing users to perform real time modulated measurements. Many spectrum analysis features are also available, such as ACPR, EVM, CCDF, Spectrum mask for advanced modulation standards like LTE and 802.11a/b/g/n/ac.

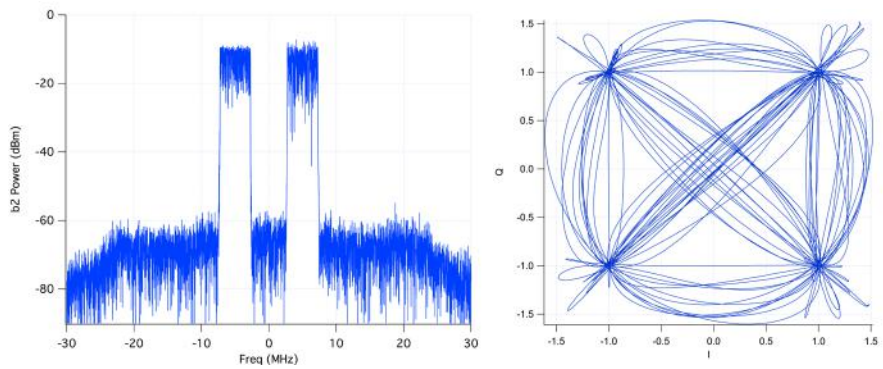

## Multi Frequency Tuning and frequency extension

By simply adding RAPID's harmonic tuning modules, users can optimize their designs for best power added efficiency, linearity and optimum power. When combined with our calibrated phase reference the user now has quick access to accurate time-domain waveforms for ultra-fast behavioral model extraction CM+.

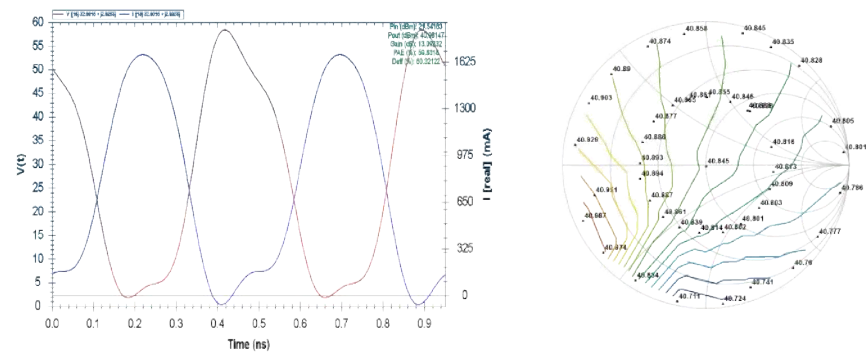

RAPID was designed for scalability, the standard 6GHz configuration can be extended up to 40GHz by adding another module.

# Model Specifications

## RAPID Models

Model	Frequency	BW	Repeatability (dB spec/type)	Dynamic Range (dB)	Pulse (ns)
RAPID-606	0.6 - 6 GHz	25/40/100 MHz	-40/-55	60	200
RAPID-1020	2 - 10 GHz	25/40/100 MHz	-40/-55	60	200
RAPID-1840	4 - 18 GHz	25/40/100 MHz	-40/-55	60	200
RAPID-2660	6 - 26 GHz	25/40/100 MHz	-40/-55	50	200
RAPID-4060	6 - 40 GHz	25/40/100 MHz	-40/-50	50	200

## RAPID Hardware Options

RAPID-MAINFRAME	Mainframe, up-conversion and down-conversion modules
RAPID-TS06	RAPID Test Set 0.6-6GHz
RAPID-TS18	RAPID Test Set 0.6-18GHz
RAPID-TS26	RAPID Test Set 1-26GHz
RAPID-TS40	RAPID Test Set 1-40GHz
RAPID-606	0.6-6GHz Digital Tuner
RAPID-1020	2-10GHz Digital Tuner
RAPID-1840	4-18GHz Digital Tuner
RAPID-2660	6-26.5GHz Digital Tuner
RAPID-4060	6-40GHz Digital Tuner
RAPID-UC26	26GHz Input drive up conversion
RAPID-UC40	40GHz Input drive up conversion

## RAPID Software Options

RAPID-CAL	Calibration Software
RAPID-INPUT	Input power measurement (a1-b1)
RAPID-PULSE	Digital tuning for pulsed signals
RAPID-B25	Tuning /Analysis Bandwidth, 25 MHz
RAPID-B40	Tuning /Analysis Bandwidth, 40 MHz
RAPID-B100	Tuning /Analysis Bandwidth, 100 MHz
RAPID-API	Application Programming Interface

## National Instruments Hardware Options

RAPID-FPGA	NI PXIe-7975R NI FlexRIO FPGA Module (Kintex-7 K410T, 2GB RAM)
RAPID-EXT	NI 5782 AC-Coupled IF Transceiver Adapter Module for NI FlexRIO
RAPID-CHASSIS	PXIe-1082, 8-Slot 3U PXI Express Chassis
RAPID-RAM	8 GB Upgrade/Replacement RAM for PXIe-8840 and PXI-8840
RAPID-PC	NI PXIe-8840 Core i5-4400E 2.7GHz, Dual Core, Win 7 (64)-bit
RAPID-DC	NI PXIe-4139 System SMU with SourceAdapt Technology
RAPID-VST-200	NI PXIe-5646R VST: 200 MHz BW
RAPID-VST-80	NI PXIe-5644/45R VST: 80 MHz BW

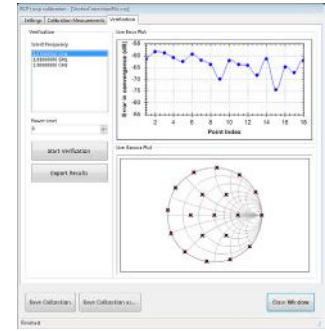

>55dB tuning accuracy over the Smith Chart (up to  $\Gamma=1$ )

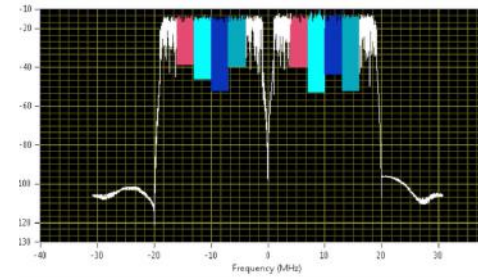

Interactive tool allows binning of spectral measurements - Impedance over bandwidth to be visualised without the need for additional averaging

