

Short Form Product Catalog 2017

YOUR CHALLENGE

IS OUR PROGRESS

About our Company

I.F. Engineering Corp was founded in 1987 by Lee & Lois Foshay and began as a microwave and RF Components consulting firm. The Foshays ran the company out of a small duplex next door to their home by Nichols College in Dudley, MA. During that time, they both managed to maintain full time jobs while they devoted all of their personal time to growing their business.

The Foshays made the decision to incorporate the business in 1994. In the following years, I.F. Engineering Corp continued to grow, forcing them to leave the duplex. In 2003, they moved in to a 7,500 square foot building in Fabyan, CT where the company achieved ISO-9001 Certification in 2008.

In 2011, I.F. Engineering Corp was able to build their own customized facility consisting of 20,000 square feet to meet the needs of their growing customer base. Now located in the new building on Foshay Road in Dudley, MA, I.F. Engineering Corp is a leading designer and manufacturer of components and sub-systems. They extend from 100 KHz through 7GHz, with an emphasis on L-Band Distribution systems. I.F. Engineering Corp, along with its dedicated employees, has made significant strides in becoming a major contender in the RF industry.

Our products are incorporated in numerous military and commercial applications such as Radar Systems, Cellular and PCS Base Stations, Earth Stations/Teleports and Communications systems.



Table of Contents

Components for Signal Processing	5
Sub-Systems and RF Assemblies	7
Power Dividers / Combiners	8
2 Way – 50 Ohms	9
2 Way – 75 Ohms	10
3 Way – 50 Ohms	11
4 Way – 50 Ohms	12
3 Way – 75 Ohms	13
4 Way – 75 Ohms	13
6 Way – 50 Ohms	14
8 Way – 50 Ohms	15
6 Way – 75 Ohms	16
8 Way – 75 ohms	16
9 Way – 50 Ohms	17
12 Way – 50 Ohms	17
16 Way – 50 Ohms	18
32 Way – 50 Ohms	18
16 Way – 75 Ohms	19
Directional Couplers	20
3 Port – 10 dB Coupling – 50 Ohms	21
3 Port – 15 dB Coupling – 50 Ohms	22
3 Port – 20 dB Coupling – 50 Ohms	22
3 Port – 10 dB Coupling – 75 Ohms	23
3 Port – 20 dB Coupling – 75 Ohms	23
4 Port – 10 dB Coupling – 50 Ohms	24
4 Port – 15 dB Coupling – 50 Ohms	24
4 Port – 30-40 dB Coupling –n 50 Ohms	24
4 Port – 20 dB Coupling – 50 Ohms	25

High Power Directional Couplers	26
Product Overview	27
Sample Offering of High Power Directional Couplers	28
Quadrature Hybrids 90°	29
Octave 4 Ports	30
Broadband 3 Port	31
Vector Modulators (I&Q)	32
Quadrature Phase Detectors	33
I & Q Demodulators	34
Multi-Couplers and Distribution Amplifiers	35
Product Overview	36
Specifying Multi-Couplers	36
L-Band Multi-Coupler – 75 Ohms	37
L-Band Multi-Coupler – 50 Ohms	37
IF-Band Multi-Coupler	38
HF-Band Multi-Coupler	38
VHF / UHF-Band Multi-Coupler	38
Ordering Information	39

Components for Signal Processing

Power Dividers (Splitters) and Combiners, Resistive

This product line covers the DC to 6 GHz frequency range in a single unit and is available in 3 port to 1 X 16 port devices. SMA and type "N" packages are the most common and we are well suited to applications that require flat response and good VSWR



Power Dividers (Splitters) and Combiners, Lumped Constant

These types of Power Dividers and Combiners have been in production for many years. Recently the engineers at I.F.E. have made major advances in extending the bandwidth and the upper limits of operation. We are now delivering broadband units that operate from 20 MHz to 3 GHz. They are available in 2 Way, 4 Way, 8 Way and 16 Way Power Dividers and Combiners.

They are offered in SMA and surface mountable packages. Other options will be available soon.

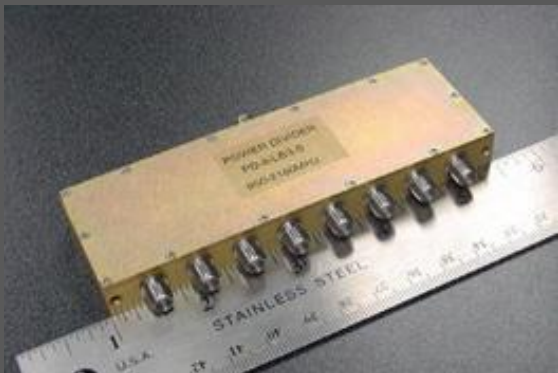

Power Dividers (Splitters) and Combiners, Coaxial

This particular Power Divider incorporates a coaxial transformer approach. This design has a very broadband response, in excess of two decades. I.F.E. offers this type of design from 1 X 2 up to 1 X 32 Divider/Combiner.





Directional Couplers

I.F.E. offers three port, four port, and Dual Directional Couplers. Our couplers offer typical coupling tolerances of <0.5 dB, directivity >20 dB, with VSWR $<1.2:1$. Standard coupling values are 6, 10, 14, 15, 16, 20 and 30 dB. The couplers are available in several connectorized packages as well as surface mountable, and operate from 0.1 MHz to 3 GHz.

Signal Control and Conversion

I.F.E. has a very comprehensive line of signal control and conversion devices. These include but are not limited to Up/Down Converters with internal phase locked L.O., Digital Attenuators, Digital Phase Shifters, Vector Modulators, Single Side-Band Modulators, Image Reject Mixers, and I&Q Demodulators/Phase Comparators..



I.F.E. offers an extensive array of broadband components for both 50 and 75 ohm systems.

These components are available in a variety of packages that include connectorized housings, TO8, Plug-In, Flat Packs and surface mountable packages.

Our designs incorporate coaxial, lumped constant, resistive, micro-strip and stripline algorithms.

Sub-Systems and RF Assemblies

L-Band Multi-Couplers / Patch Panels (75 Ohm)

These Multi-Couplers are available in a variety of configurations and frequency ranges. The mechanical configurations vary from 1RU high to 6RU high chassis.

The 1RU configuration has a maximum of sixteen (16) outputs and four (4) channels. The 2RU versions are available with thirty-two (32) outputs and from one (1) to eight (8) input channels.

Present designs in 6RU chassis's have one hundred twenty-eight (128) outputs and from one (1) to sixteen (16) input channels.

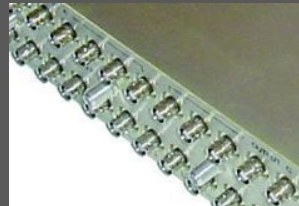

C-Band Power Dividers / Combiners

I.F.E. manufactures a complete line of C-Band Power Dividers and Combiners for Down/Uplink facilities and Matrix Switch applications.

These are available in several packages, which include type "N", SMA, and OSP connectorized versions as well as Surface Mountable devices.

The standard configurations are: two (2) Way, four (4) Way, eight (8) Way, sixteen (16) Way and thirty-two (32) Way.

The available frequency ranges are: CB1 3.7 to 4.2 GHz (receive), CB2 5.8 to 6.5 GHz (transit), CB3 3.6 to 6.6 GHz (dual range).

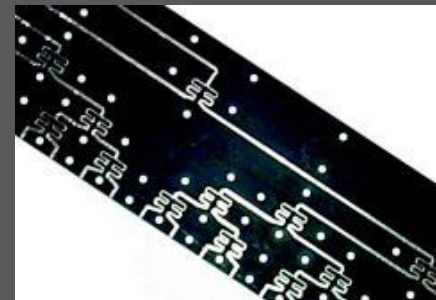

Switching Products

I.F.E. manufactures several types of switch products covering the 0.1 MHz to 2.5 GHz frequency range. Our designs incorporate P.I.N. diodes, Electro-Mechanical, and GaAs devices. The designs include 1 X 2 through 1 X 16, and transfer switching.



Power Dividers / Combiners

I.F. ENGINEERING
PD-24006-S-RE
OUFA1

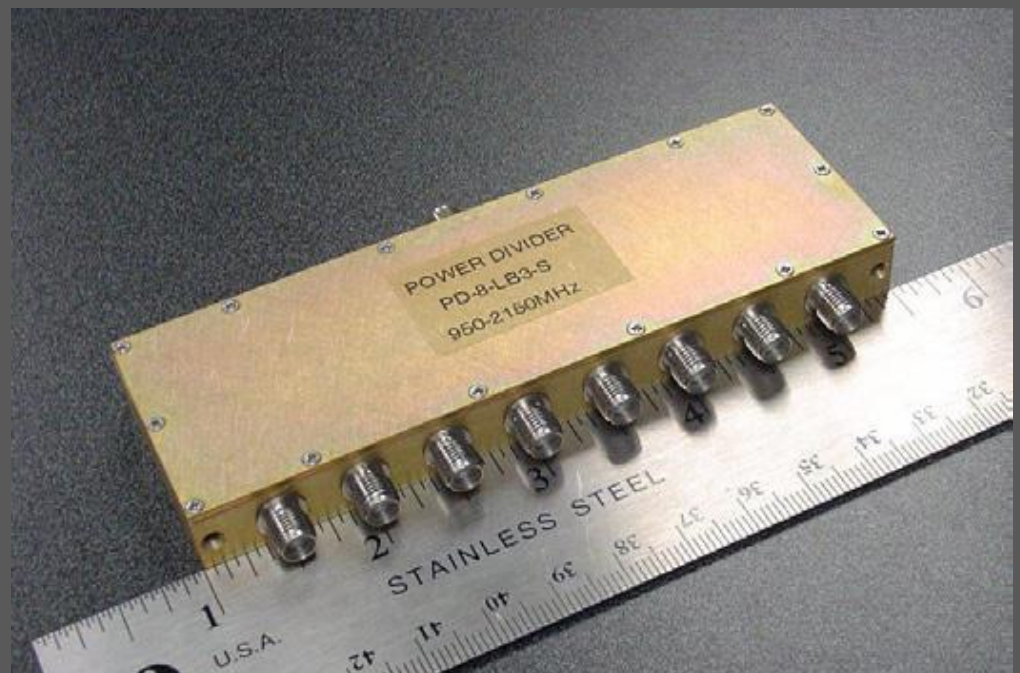

Power Dividers / Combiners

2 Way – 50 Ohms

Part Number	Frequency (MHz)	Insertion Loss (dB)	Isolation (dB)	VSWR In/Out	Input Power (W)	Connector Type	Outline
PD-2001-S	0.5 - 32	0.3	40	1.1:1 / 1.1:1	3	SMA	2-S-1
PD-2001-S-100K	0.1 - 32	0.3	40	1.1:1 / 1.1:1	3	SMA	2-S-1
PD-2001-B	0.5 - 32	0.3	40	1.1:1 / 1.1:1	3	BNC	2-B
PD-2001-N	0.5 - 32	0.3	40	1.1:1 / 1.1:1	3	N	2-N
PD-2001-SM	0.5 - 32	0.3	33	1.2:1 / 1.2:1	1	Surface Mount	2-SM
PD-2002-S	2 - 100	0.4	35	1.3:1 / 1.3:1	3	SMA	2-S
PD-2002-B	2 - 100	0.35	35	1.3:1 / 1.3:1	3	BNC	2-B
PD-2002-N	2 - 100	0.35	35	1.3:1 / 1.3:1	3	N	2-N
PD-2002-SM	2 - 100	0.35	35	1.2:1 / 1.2:1	1	Surface Mount	2-S
PD-2003-S	10 - 500	0.65	30	1.3:1 / 1.3:1	3	SMA	2-S
PD-2003-B	10 - 500	0.65	30	1.3:1 / 1.3:1	3	BNC	2-B
PD-2003-N	5 - 500	0.75	30	1.3:1 / 1.3:1	3	N	2-N
PD-2003-SM	5 - 500	0.65	30	1.3:1 / 1.3:1	1	Surface Mount	2-SM
PD-2003-S-25W	10 - 510	0.75	25	1.4:1 / 1.3:1	25	SMA	2-S-1
PD-2004-S	10 - 1000	0.75	25	1.3:1 / 1.3:1	3	SMA	2-S
PD-2004-B	20 - 1000	1.00	22	1.4:1 / 1.4:1	3	BNC	2-B
PD-2004-N	10 - 1000	0.75	25	1.2:1 / 1.2:1	3	N	2-N
PD-2004-SM	10 - 1000	0.75	25	1.3:1 / 1.3:1	1	Surface Mount	2-SM
PD-2007-S	20 - 2000	1.50	18	1.4:1 / 1.3:1	1	SMA	2-S
PD-2007-N	20 - 2000	1.50	18	1.4:1 / 1.3:1	1	N	2-N
PD-2007-SM	20 - 2000	2.00	18	1.5:1 / 1.5:1	1	Surface Mount	2-SM
PD-2008-S	20 - 3000	2.00	18	1.5:1 / 1.5:1	1	SMA	2-S
PD-2008-N	20 - 3000	2.00	18	1.5:1 / 1.5:1	1	N	2-N
PD-2008-SM	20 - 3000	2.00	18	1.5:1 / 1.4:1	1	Surface Mount	2-SM
PD-2-LB3-S	950 - 2150	0.75	18	1.4:1 / 1.4:1	2	SMA	2-S
PD-2-LB3-B	950 - 2150	1.00	15	1.5:1 / 1.3:1	2	BNC	2-B
PD-2-LB3-N	950 - 2150	1.00	18	1.5:1 / 1.5:1	2	N	2-N
PD-2R-4200-S	0.5 - 4200	6.0 ± 1.0	6	1.5:1 / 1.5:1	0.1	SMA	2-S

Power Dividers / Combiners

2 Way – 75 Ohms

Part Number	Frequency (MHz)	Insertion Loss (dB)	Isolation (dB)	VSWR In/Out	Input Power (W)	Connector Type
PD-2-VHF-B-75	20 - 200	0.50	25	1.3:1 / 1.3:1	2	BNC
PD-2003-B-75	10 – 500	0.65	25	1.3:1 / 1.3:1	2	BNC
PD-2004-B-75	20 – 1000	0.85	22	1.4:1 /1.4:1	2	BNC
PD-2007-B-75	10 – 2000	2.50	15	1.5:1 /1.5:1	2	BNC
PD-2-LB3-B-75	950 – 2150	1.00	15	1.75:1 /1.5:1	2	BNC
PD-2-LB3-F	950 - 2150	0.75	18	1.5:1 /1.3:1	2	Type F
PD-2-LB3-F-DC (DC Passone Port)	950 – 2150	1.00	18	1.5:1 /1.3:1	2	Type F

Power Dividers / Combiners

3 Way – 50 Ohms

Part Number	Frequency (MHz)	Insertion Loss (dB)	Isolation (dB)	VSWR In/Out	Input Power (W)	Connector Type	Outline
PD-3001-S	0.5 – 32	0.50	35	1.3:1 / 1.3:1	3	SMA	3-S
PD-3001-SM	0.5 – 32	0.50	35	1.3:1 / 1.3:1	1	Surface Mount	3-SM
PD-3002-S	2 – 100	0.50	30	1.3:1 / 1.3:1	3	SMA	3-S
PD-3002-B	2 – 100	0.75	30	1.3:1 / 1.3:1	3	BNC	3-B
PD-3-VHF-N	5 – 200	1.00	25	1.3:1 / 1.3:1	3	N	3-N
PD-3003-S	10 – 500	0.75	25	1.3:1 / 1.3:1	3	SMA	3-S
PD-3003-B	10 – 500	0.75	22	1.3:1 / 1.3:1	3	BNC	3-B
PD-3003-N	10 – 500	1.00	25	1.3:1 / 1.3:1	3	N	3-N
PD-3003-SM	10 – 500	0.95	22	1.3:1 / 1.3:1	1	Surface Mount	3-SM
PD-3004-S	20 – 1000	1.50	25	1.4:1 / 1.4:1	2	SMA	3-S
PD-3004-B	20 – 1000	1.75	22	1.4:1 / 1.4:1	2	BNC	3-B
PD-3004-N	20 – 1000	1.25	22	1.4:1 / 1.3:1	2	N	3-N
PD3004-SM	20 - 1000	1.75	20	1.4:1 / 1.4:1	1	Surface Mount	3-SM

Power Dividers / Combiners

4 Way – 50 Ohms

Part Number	Frequency (MHz)	Insertion Loss (dB)	Isolation (dB)	VSWR In/Out	Input Power (W)	Connector Type	Outline
PD-4001-S-100K	0.1 – 32	0.30	40	1.2:1 / 1.2:1	3	SMA	4-S
PD-4001-S	0.5 – 32	0.50	40	1.15:1 / 1.15:1	3	SMA	4-S
PD-4001-B	1.0 – 32	0.50	40	1.2:1 / 1.2:1	3	BNC	4-B
PD-4001-SM	0.5 – 32	0.75	33	1.37:1 / 1.2:1	1	Surface Mount	4-SM
PD-4002-S	2 – 100	0.5	30	1.2:1 / 1.2:1	3	SMA	4-S
PD-4002-B	2 – 100	0.5	30	1.2:1 / 1.2:1	3	BNC	4-B
PD-4002-SM	2 – 100	0.5	30	1.25:1 / 1.25:1	1	Surface Mount	4-SM
PD-4003-S	10 – 500	0.75	30	1.3:1 / 1.3:1	3	SMA	4-S
PD-4003-B	10 – 500	1.20	25	1.3:1 / 1.3:1	3	BNC	4-B
PD-4003-N	10 – 500	0.75	25	1.3:1 / 1.3:1	3	N	4-N
PD-4003-SM	10 – 500	0.75	20	1.4:1 / 1.3:1	1	Surface Mount	4-SM
PD-4004-S	20 – 1000	1.75	25	1.3:1 / 1.3:1	3	SMA	4-S
PD-4004-B	20 – 1000	1.75	25	1.3:1 / 1.3:1	3	BNC	4-B
PD-4004-SM	10 – 1000	1.50	25	1.4:1 / 1.3:1	1	Surface Mount	4-SM
PD-4004-FP	20 – 1000	1.50	25	1.3:1 / 1.3:1	1	Flat Pack	4-FP
PD-4007-S	20 – 2000	2.00	20	1.5:1 / 1.3:1	1	SMA	4-S
PD-4007-N	20 – 2000	2.00	15	1.8:1 / 1.6:1	1	N	4-N
PD-4007-SM	20 – 2000	2.00	22	1.5:1 / 1.3:1	1	Surface Mount	4-SM
PD-4008-S	20 – 3000	2.25	15	1.5:1 / 1.3:1	1	SMA	4-S
PD-4008-SM	20 – 3000	2.25	18	1.5:1 / 1.4:1	1	Surface Mount	4-SM
PD-4-LB3-S	950 – 2150	1.00	18	1.5:1 / 1.3:1	1	SMA	4-S
PD-4-LB3-B-50	950 – 2150	2.00	15	1.75:1 / 1.5:1	1	BNC	4-B
PD-4-LB3-N-50	950 - 2150	2.50	15	1.5:1 / 1.5:1	1	N	4-N
PD-4-LB3-S-DS	950 – 2150	2.00	15	1.5:1 / 1.5:1	1	SMA	4-S

Power Dividers / Combiners

3 Way – 75 Ohms

Part Number	Frequency (MHz)	Insertion Loss (dB)	Isolation (dB)	VSWR In/Out	Input Power (W)	Connector Type
PD-3003-B-75	5 – 500	1.00	22	1.5:1 / 1.5:1	2	BNC

4 Way – 75 Ohms

Part Number	Frequency (MHz)	Insertion Loss (dB)	Isolation (dB)	VSWR In/Out	Input Power (W)	Connector Type
PD-4-VHF-B-75	20 – 200	1.0	25	1.3:1 / 1.3:1	2	BNC
PD-4003-B-75	10 – 500	1.3	25	1.5:1 / 1.5:1	2	BNC
PD-4004-B-75	20 – 1000	1.5	24	1.5:1 / 1.4:1	2	BNC
PD-4-LB2-F	950 – 1750	1.0	18	1.5:1 / 1.5:1	2	Type F
PD-4-LB3-B-75	950 – 2150	2.0	15	1.75:1 / 1.5:1	2	BNC
PD-4-LB3-F	950 – 2150	2.0	15	1.75:1 / 1.5:1	2	Type F

Power Dividers / Combiners

6 Way – 50 Ohms

Part Number	Frequency (MHz)	Insertion Loss (dB)	Isolation (dB)	VSWR In/Out	Input Power (W)	Connector Type	Outline
PD-6001-S	0.5 – 32	0.65	30	1.2:1 / 1.2:1	3	SMA	6-S
PD-6002-S	2 – 100	0.75	30	1.3:1 /1.3:1	2	SMA	6-S
PD-6003-S	10 - 500	1.25	25	1.3:1 /1.3:1	2	SMA	6-S
PD-6003-B	10 – 500	1.50	25	1.4:1 /1.3:1	2	BNC	6-B
PD-6003-N	20 – 500	1.50	25	1.3:1 /1.3:1	2	N	6-N
PD-6004-S	20 – 1000	2.00	25	1.3:1 /1.3:1	2	SMA	6-S
PD-6R-4200-S	DC – 4200	15 ± 2	6	1.4:1 /1.4:1	0.1	SMA	6-S

Power Dividers / Combiners

8 Way – 50 Ohms

Part Number	Frequency (MHz)	Insertion Loss (dB)	Isolation (dB)	VSWR In/Out	Input Power (W)	Connector Type	Outline
PD-8001-S	0.1 – 32	0.80	40	1.2:1 / 1.2:1	3	SMA	8-S
PD-8001-B	0.5 - 32	0.50	40	1.2:1 / 1.2:1	3	BNC	8-B
PD-8001-N	0.5 – 32	0.80	40	1.2:1 / 1.2:1	3	N	8-N
PD-8001-SM	0.5 – 32	1.00	33	1.3:1 / 1.3:1	1	Surface Mount	8-SM
PD-8002-S	2 – 100	1.00	30	1.2:1 / 1.2:1	3	SMA	8-S
PD-8002-B	2 – 100	1.00	30	1.2:1 / 1.2:1	3	BNC	8-B
PD-8003-S	10 – 500	2.00	30	1.4:1 / 1.3:1	3	SMA	8-S
PD-8003-B	10 – 500	1.50	25	1.3:1 / 1.3:1	3	BNC	8-B
PD-8003-N	5 – 500	1.50	30	1.3:1 / 1.3:1	3	N	8-N
PD-8003-SM	10 – 500	1.50	25	1.4:1 / 1.3:1	1	Surface Mount	8-SM
PD-8004-S	20 – 1000	2.00	25	1.5:1 / 1.5:1	2	SMA	8-S
PD-8004-SM	20 – 1000	2.00	23	1.5:1 / 1.5:1	1	Surface Mount	8-SM
PD-8007-S	20 – 2000	3.25	18	1.6:1/1.4:1	1	SMA	8-S
PD-8007-N	20 – 2000	3.50	18	1.75:1/1.75:1	1	N	8-N
PD-8007-SM	20 – 2000	3.00	18	1.6:1/1.5:1	1	Surface Mount	8-SM
PD-8008-S	20 – 3000	3.50	18	1.6:1/1.5:1	1	SMA	8-S
PD-8008-N	30 – 3000	4.50	18	1.8:1/1.5:1	1	N	8-N
PD-8008-SM	20 – 3000	4.00	15	1.8:1/1.6:1	1	Surface Mount	8-SM
PD-8-LB3-B-50	950 - 2150	2.00	15	1.75:1 / 1.5:1	1	BNC	8-B
PD-8-LB3-N-50	950 – 2150	3.00	18	1.6:1/1.5:1	1	N	8-N
PD-8-LB3-S	950 – 2150	2.00	15	2.0:1/1.75:1	1	SMA	8-S

Power Dividers / Combiners

6 Way – 75 Ohms

Part Number	Frequency (MHz)	Insertion Loss (dB)	Isolation (dB)	VSWR In/Out	Input Power (W)	Connector Type
PD-6003-B-75	5 – 500	1.5	22	1.5:1 / 1.5:1	2	BNC

8 Way – 75 Ohms

Part Number	Frequency (MHz)	Insertion Loss (dB)	Isolation (dB)	VSWR In/Out	Input Power (W)	Connector Type
PD-8002-B-75	2 – 100	1.00	30	1.2:1 / 1.2:1	2	BNC
PD-8-VHF-B-75	50 – 180	1.00	25	1.3:1 / 1.3:1	2	BNC
PD-8003-B-75	10 – 500	1.25	25	1.3:1 / 1.3:1	2	BNC
PD-8-LB3-B	950 – 2150	2.00	15	2.0:1 / 1.75:1	2	BNC
PD-8-LB3-F	950 – 2150	2.00	15	2.0:1 / 1.75:1	2	Type F

Power Dividers / Combiners

9 Way – 50 Ohms

Part Number	Frequency (MHz)	Insertion Loss (dB)	Isolation (dB)	VSWR In/Out	Input Power (W)	Connector Type	Outline
PD-9003-S	5 – 500	1.25	25	1.5:1 / 1.3:1	3	SMA	9-S
PD-9004-S	20 – 1000	2.50	22	1.6:1 / 1.3:1	2	SMA	9-S

12 Way – 50 Ohms

Part Number	Frequency (MHz)	Insertion Loss (dB)	Isolation (dB)	VSWR In/Out	Input Power (W)	Connector Type	Outline
PD-12001-S-100K	0.1 – 32	1.25	30	1.4:1 / 1.3:1	2	SMA	12-S
PD-12001-B	0.5 – 32	1.00	40	1.3:1 / 1.3:1	2	BNC	12-B
PD-12001-SM	2.0 – 32	1.00	30	1.2:1 / 1.2:1	1	Surface Mount	12-SM
PD-12002-S	2 – 100	1.25	30	1.3:1 / 1.3:1	2	SMA	12-S
PD-12002-B	2 – 100	1.20	30	1.3:1 / 1.3:1	2	BNC	12-B
PD-12002-B-ENV	2 – 100	1.10	30	1.3:1 / 1.3:1	2	BNC	12-B
PD-12-036-SM	20 - 200	1.50	25	1.4:1 / 1.4:1	1	Surface Mount	12-SM
PD-12003-S	10 – 500	1.50	25	1.3:1 / 1.3:1	2	SMA	12-S
PD-12003-S-5W	10 – 500	1.50	25	1.3:1 / 1.3:1	5	SMA	12-S
PD-12003-P	10 – 500	1.60	20	1.4:1 / 1.4:1	1	Thru Hole	12-P
PD-12004-S	50 – 1000	2.60	20	1.5:1 / 1.4:1	2	SMA	12-S
PD-12004-SM	20 – 1000	2.25	18	1.6:1 / 1.6:1	1	Surface Mount	12-SM
PD-12005-S	25 – 1200	2.50	20	1.8:1 / 1.3:1	2	SMA	12-S

Power Dividers / Combiners

16 Way – 50 Ohms

Part Number	Frequency (MHz)	Insertion Loss (dB)	Isolation (dB)	VSWR In/Out	Input Power (W)	Connector Type	Outline
PD-16001-S-100K	0.1 – 32	0.75	35	1.3:1 / 1.3:1	2	SMA	16-S
PD-16001-B	0.5 - 30	0.75	40	1.2:1 / 1.2:1	2	BNC	16-B
PD-16001-B-40M	1.0 – 40	1.75	33	1.3:1 / 1.3:1	2	BNC	16-B
PD-16002-S	2 – 100	1.50	30	1.3:1 / 1.3:1	2	SMA	16-S
PD-16003-S-5W	20 – 500	2.50	20	1.5:1 / 1.5:1	5	SMA	16-S
PD-16004-S	20 – 1000	2.50	25	1.5:1 / 1.5:1	2	SMA	16-S
PD-16004-SM	20 – 1000	2.50	20	1.5:1 / 1.5:1	2	Surface Mount	16-SM
PD-16008-SM	20 – 3000	4.50	16	1.8:1 / 1.8:1	1	Surface Mount	16-SM
PD-16008-S	30 – 3000	4.50	18	1.8:1 / 1.8:1	1	SMA	16-S
PD-16-LB3-S	950 – 2150	2.25	18	1.7:1 / 1.4:1	1	SMA	16-S
PD-16-LB3-SMB	950 – 2150	2.80	15	1.7:1 / 1.4:1	1	SMB (Male)	16-SMB

32 Way – 50 Ohms

Part Number	Frequency (MHz)	Insertion Loss (dB)	Isolation (dB)	VSWR In/Out	Input Power (W)	Connector Type	Outline
PD-32001-S	0.5 – 32	1.0	40	1.2:1 / 1.2:1	2	SMA	32-S-1
PD-32-LB3-S	950 - 2150	3.6	15	1.7:1 / 1.4:1	2	SMA	32-S-2
PD-32-CB1-S-OSP	3400 – 4300	4.0	16.5	1.5:1 / 1.5:1	2	SMA / OSP	32-S-3
PD-32-CB3-S-OSP	3700 - 6450	4.0	16.5	1.6:1 / 1.8:1	2	SMA / OSP	32-S-3

Power Dividers / Combiners

16 Way – 75 Ohms

Part Number	Frequency (MHz)	Insertion Loss (dB)	Isolation (dB)	VSWR In/Out	Input Power (W)	Connector Type
PD-16-LB3-B-75	950 - 2150	3.0	18	1.8:1 / 1.5:1	2	BNC
PD-16-LB3-F	950 - 2150	3.5	18	1.8:1 / 1.5:1	2	Type F

Directional Couplers

I.F. ENGINEERING
PD-24006-S-RE
OUFA1

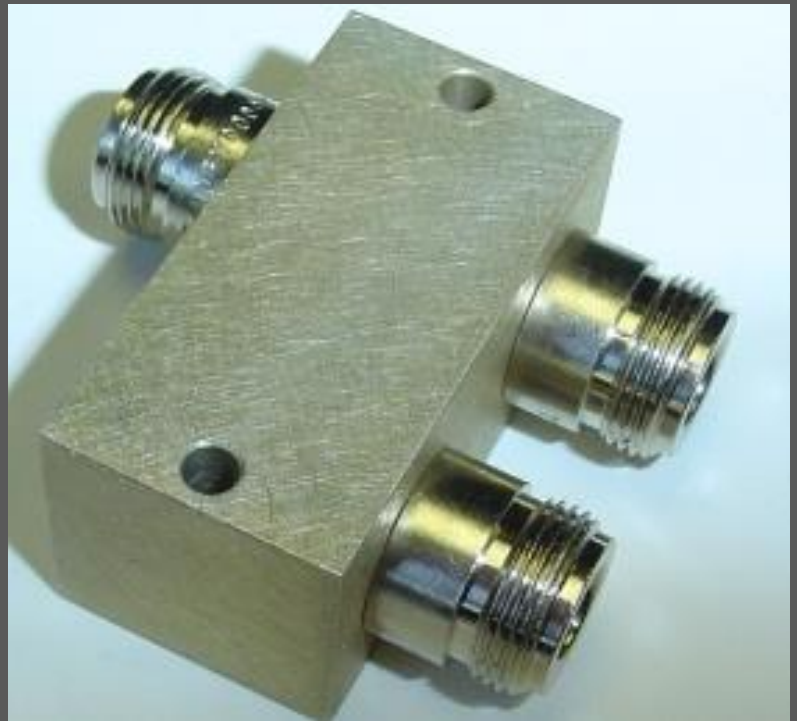

Directional Couplers

3 Port – 10 dB Coupling – 50 Ohms

Part Number	Frequency (MHz)	Coupling (dB)	Insertion Loss (dB)	Directivity (dB)	VSWR In/Out	Input Power (W)	Connector Type
C3-10-001-S	0.5 - 32	10	0.75	22	1.2:1	2	SMA
C3-10-001-B	0.5 - 32	10	0.75	22	1.2:1	2	BNC
C3-10-001-N	0.5 - 32	10	0.75	22	1.2:1	2	N
C3-10-002-S	2 - 100	10	0.50	25	1.3:1	2	SMA
C3-10-002-B	2 - 100	10	0.50	25	1.3:1	2	BNC
C3-10-002-N	2 - 100	10	0.50	25	1.3:1	2	N
C3-10-VHF-B-50	20 - 200	10	0.65	25	1.3:1	2	BNC
C3-10-003-S	10 - 500	10	0.65	25	1.3:1	2	SMA
C3-10-003-B	10 - 500	10	0.65	25	1.3:1	2	BNC
C3-10-003-N	10 - 500	10	0.65	25	1.3:1	2	N
C3-10-004-S	20 - 1000	10	1.00	20	1.4:1	2	SMA
C3-10-004-B	20 - 1000	10	1.00	20	1.4:1	2	BNC
C3-10-004-N	20 - 1000	10	1.00	20	1.4:1	2	N
C3-10-006-S	20 - 1200	10	1.00	20	1.3:1	2	SMA
C3-10-007-S	20 - 1200	10	1.50	15	1.5:1	2	SMA
C3-10-2500-S	20 - 2500	10	2.10	15	1.5:1	2	SMA
C3-11-034-SM	20 - 2500	10	2.50	10	2.0:1	2	Surface Mount
C3-10-LB2-S	950 - 1750	10	0.75	15	1.4:1	2	SMA
C3-10-LB2-N	950 - 1750	10	0.70	16	1.2:1	2	N
C3-10-LB3-S	950 - 2150	10	0.75	15	1.4:1	2	SMA
C3-10-LB3-N	950 - 2150	10	1.20	14	1.5:1	2	N

Directional Couplers

3 Port – 15 dB Coupling – 50 Ohms

Part Number	Frequency (MHz)	Coupling (dB)	Insertion Loss (dB)	Directivity (dB)	VSWR In/Out	Input Power (W)	Connector Type
C3-15-001-S	0.5 – 32	15	0.35	30	1.3:1	3	SMA
C3-15-003-S	10 – 500	15	0.85	25	1.4:1	3	SMA
C3-15-003-N	10 – 500	15	0.85	25	1.4:1	3	N
C3-15-004-S	20 – 1000	15	0.85	20	1.4:1	2	SMA
C3-15-004-N	20 – 1000	15	0.75	20	1.4:1	2	N

3 Port – 20 dB Coupling – 50 Ohms

Part Number	Frequency (MHz)	Coupling (dB)	Insertion Loss (dB)	Directivity (dB)	VSWR In/Out	Input Power (W)	Connector Type
C3-20-001-S	0.5 – 32	20	0.35	30	1.3:1	3	SMA
C3-20-001-B-5W	0.5 – 32	20	0.35	35	1.3:1	5	BNC
C3-20-002-S	2 – 100	20	0.35	25	1.3:1	2	SMA
C3-20-002-B	2 – 100	20	0.35	25	1.3:1	2	BNC
C3-20-IF-B	5 – 140	20	0.50	25	1.2:1	2	BNC
C3-20-VHF-B-50	20 – 200	20	0.65	25	1.3:1	2	BNC
C3-20-003-S	10 – 500	20	0.65	25	1.3:1	2	SMA
C3-20-003-B	10 – 500	20	0.65	25	1.3:1	2	BNC
C3-20-003-N	10 – 500	20	0.65	25	1.3:1	2	N
C3-20-004-S	20 – 1000	20	0.75	20	1.4:1	2	SMA
C3-20-004-N	20 – 1000	20	0.75	20	1.4:1	2	N
C3-20-004-5W	20 – 1000	20	1.00	15	1.3:1	5	SMA
C3-20-006-S	20 – 1200	20	0.75	20	1.3:1	2	SMA
C3-18-008-S	20 – 3000	18	2.00	10	1.6:1	1	SMA
C3-20-LB2-N	950 – 1750	20	1.25	15	1.4:1	1	N
C3-20-LB3-S	950 – 2150	20	0.50	15	1.3:1	1	SMA
C3-30-500-S-10W	50 – 525	30	0.30	20	1.2:1	10	SMA

Directional Couplers

3 Port – 10 dB Coupling – 75 Ohms

Part Number	Frequency (MHz)	Coupling (dB)	Insertion Loss (dB)	Directivity (dB)	VSWR In/Out	Input Power (W)	Connector Type
C3-10-VHF-B-75	50 - 90	10	0.65	25	1.3:1	2	BNC
C3-10-003-B-75	10 – 500	10	0.65	25	1.3:1	2	BNC
C3-10-004-B-75	20 – 1000	10	1.00	20	1.4:1	2	BNC
C3-10-004-F	20 – 1000	10	1.00	20	1.4:1	2	Type F
C3-10-LB2-F	950 – 1750	10	1.00	16	1.6:1	2	Type F
C3-10-LB3-B-75	950 – 2150	10	1.20	15	1.75:1	2	BNC
C3-10-LB3-F	950 – 2150	10	1.20	14	1.75:1	2	Type F

3 Port – 20 dB Coupling – 75 Ohms

Part Number	Frequency (MHz)	Coupling (dB)	Insertion Loss (dB)	Directivity (dB)	VSWR In/Out	Input Power (W)	Connector Type
C3-20-VHF-B-75	50 - 140	20	0.50	25	1.3:1	2	BNC
C3-20-LB2-B-75	950 – 1750	20	1.25	15	1.6:1	1	BNC
C3-20-LB2-F	950 – 1750	20	1.25	15	1.6:1	1	Type F
C3-20-LB3-B-75	950 – 2150	20	1.5	15	1.75:1	1	BNC
C3-20-LB3-F	950 – 2150	20	1.5	15	1.75:1	1	Type F

Directional Couplers

4 Port – 10 dB Coupling – 50 Ohms

Part Number	Frequency (MHz)	Coupling (dB)	Insertion Loss (dB)	Directivity (dB)	VSWR In/Out	Input Power (W)	Connector Type
C4-10-001-S	0.5 - 32	10	0.75	22	1.3:1	2	SMA
C4-10-001-B	0.5 - 32	10	0.75	22	1.3:1	2	BNC
C4-10-001-N-50W	0.5 - 32	10	0.75	22	1.3:1	50	N
C4-10-004-S	20 - 1000	10	1.50	20	1.4:1	2	SMA
C4-10-007-S	20 - 2000	10	1.70	12	1.5:1	1	SMA
C4-10-2500-S	20 - 2500	10	2.10	15	1.5:1	1	SMA

4 Port – 15 dB Coupling – 50 Ohms

Part Number	Frequency (MHz)	Coupling (dB)	Insertion Loss (dB)	Directivity (dB)	VSWR In/Out	Input Power (W)	Connector Type
C4-15-001-S	0.5 - 32	15	0.35	30	1.3:1	3	SMA
C4-15-001-N	0.5 - 32	15	0.35	30	1.3:1	3	N
C4-15-003-S	10 - 500	15	0.65	20	1.3:1	3	SMA
C4-15-003-N	10 - 500	15	0.65	18	1.3:1	3	N
C4-15-004-S	20 - 1000	15	1.50	20	1.4:1	2	SMA

4 Port – 30 – 40 dB Coupling – 50 Ohms

Part Number	Frequency (MHz)	Coupling (dB)	Insertion Loss (dB)	Directivity (dB)	VSWR In/Out	Input Power (W)	Connector Type
C4-30-002-N-100W	5 - 100	30	0.20	25	1.2:1	100	N
C40-30-500-S-10W	50 - 525	30	0.30	20	1.2:1	10	SMA
C4-40-400-S-100W	20 - 400	40	0.30	10	1.2:1	100	SMA

Directional Couplers

4 Port – 20 dB Coupling – 50 Ohms

Part Number	Frequency (MHz)	Coupling (dB)	Insertion Loss (dB)	Directivity (dB)	VSWR In/Out	Input Power (W)	Connector Type
C4-20-001-B	0.5 – 32	20	0.35	30	1.3:1	3	BNC
C4-20-001-B-5W	0.5 – 32	20	0.35	35	1.3:1	5	BNC
C4-20-001-N-50W	0.5 - 32	20	0.75	25	1.2:1	50	N
C4-20-IF-B	5 – 140	20	0.50	25	1.2:1	2	BNC
C4-20-VHF-B-50	20 – 200	20	0.65	25	1.3:1	2	BNC
C4-058	20 – 200	23.5	0.2	30	1.3:1	100	Surface Mount
C4-20-003-S	10 – 500	20	0.65	25	1.3:1	2	SMA
C4-20-003-B	10 – 500	20	0.65	25	1.3:1	2	BNC
C4-20-003-N-50W	20 – 500	20	0.30	18	1.25:1	50	N
C4-20-003-N-100W	20 – 500	20	0.30	18	1.25:1	100	N
C4-028	30 – 512	20	0.35	15	1.25:1	100	Surface Mount
C4-033	20 – 512	20	0.30	18	1.25:1	120	Surface Mount
C4-052	137 – 550	22	0.22	20	1.25:1	25	Surface Mount
C4-063	20 – 512	19	0.40	22	1.25:1	100	Surface Mount
C4-20-004-N	20 – 1000	20	0.60	15	1.4:1	2	N
C4-20-004-S-5W	20 – 1000	20	0.75	15	1.3:1	5	SMA
C4-037	174 – 1000	20	0.60	15	1.35:1	15	Surface Mount
C4-062	25 - 1000	15	0.70	15	1.4:1	25	Surface Mount
C4-18-008-S	20 – 3000	18	2.00	10	1.6:1	2	SMA
C4-20-LB3-N	950 - 2150	20	1.20	13	1.8:1	2	N

High Power Directional Couplers

I.F. ENGINEERING
PD-24006-S-RE
OUFA1

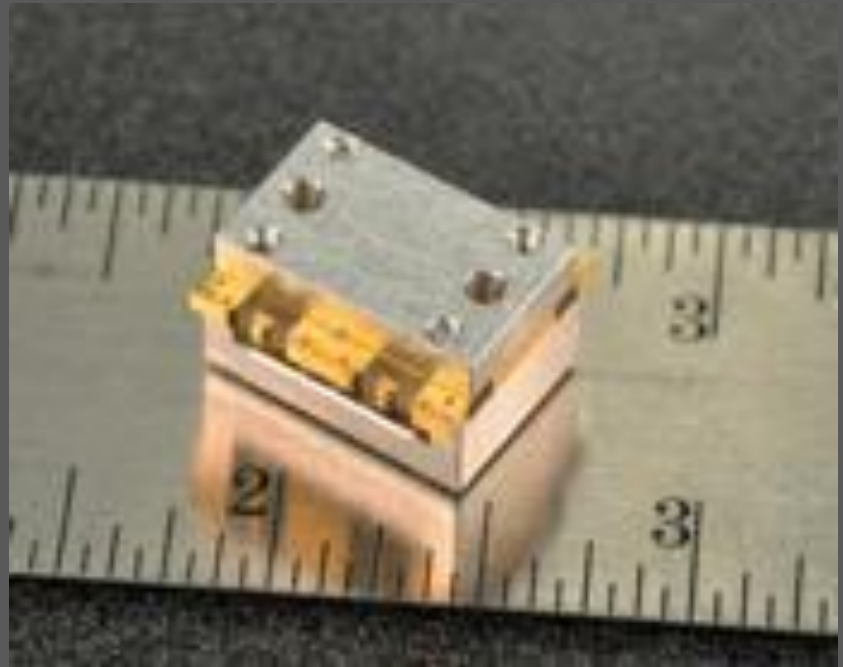

High Power Directional Couplers

Product Overview

I.F. Engineering High Power Directional Couplers are some of the best in the industry today.

Offering includes power handling capabilities from 25 W CW to 150 W CW.

Housed in a low profile enclosure, product is available in Surface Mount or Connectorized Packages.

Product Features

Power Capabilities from 25 W CW to 150 W CW

Frequency Ranges 0.5 MHz to 1 GHz

Available in Surface Mount or Connectorized Packages

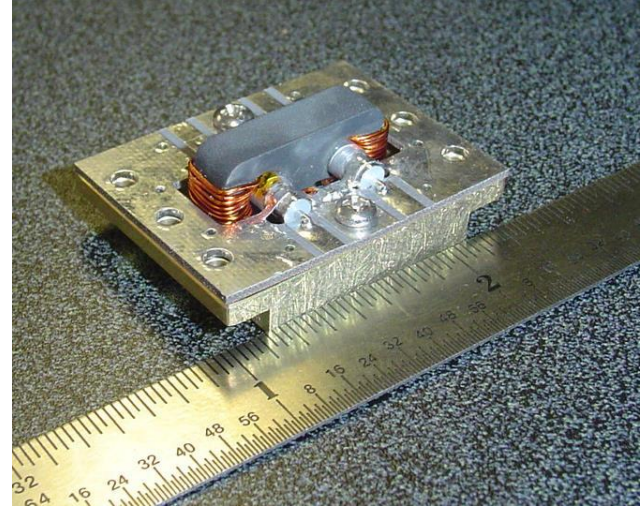

Typical Applications

High VSWR Amplifier

Fold Back

Power Leveling

Signal Monitoring

Directional Coupler
20 dB
C4-033 (100 Watt)

Frequency Range 30 – 512 MHz
Insertion Loss 0.28 dB includes Coupling Loss
VSWR In/Out 1.25:1
Coupling 20 ± 2.0 dB
Directivity 20 dB
Surface Mount

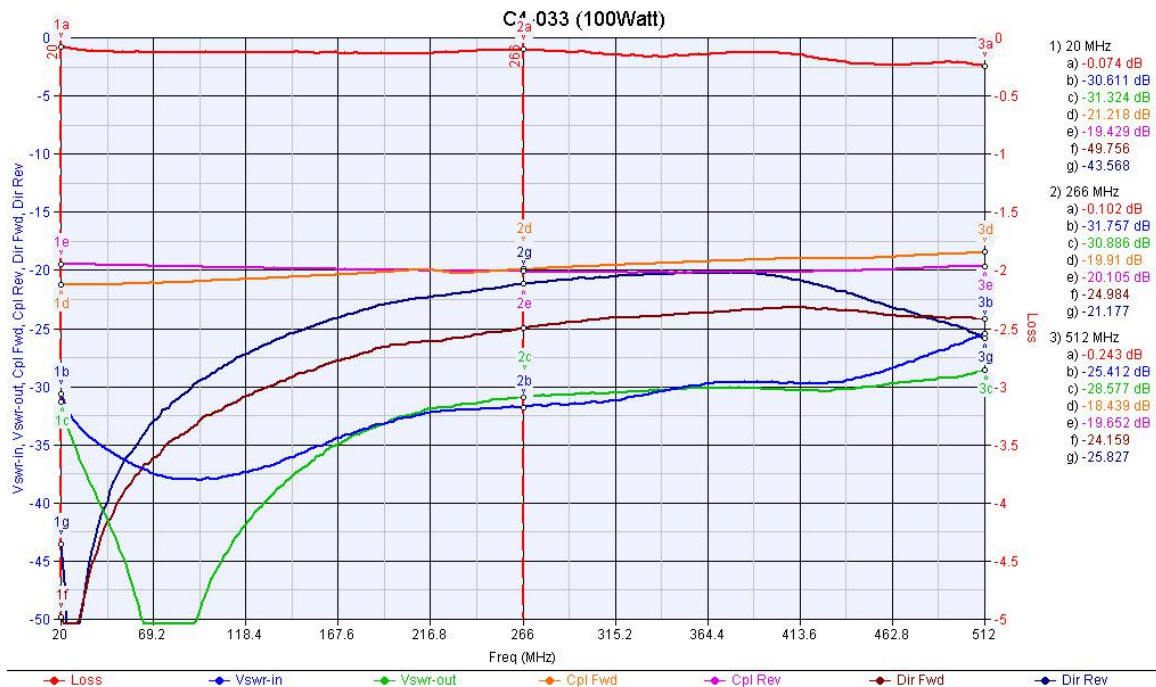

High Power Directional Couplers

Sample Offering of High Power Directional Couplers

Part Number	Frequency (MHz)	Coupling (dB)	Insertion Loss (dB) Includes Coupling Loss	Directivity (dB)	VSWR In/Out	Input Power (W)	Connector Type
C4-033	30 – 512	20 ± 2.0	0.28	20	1.3:1	100	SMT
C4-042	30 – 1000	20 ± 2.0	0.65	15		15	SMT
C4-043	20 – 550	20 ± 1.0	0.25	20	1.3:1	10	SMT
C4-054	20 – 137	24 ± 1.0	0.15	20	1.2:1	100	SMT
C4-056	137 – 550	22 ± 2.0	0.22	20	1.3:1	25	SMT
C4-058	20 – 200	23.5 ± 0.75	0.2	30		100	SMT
C4-060	500 – 1000	16 ± 2.5	0.75	15	1.3:1	15	SMT
C4-060	20 – 500	16 ± 2.0	0.5	20	1.3:1	20	SMT
C4-061	20 – 500	14 ± 2.0	0.6	20		15	SMT
C4-061	500 – 1000	14 ± 2.5	0.85	15	1.4:1	15	SMT
C4-062	25 – 1000	15 ± 2.0	0.7	15	1.4:1	25	SMT
C4-063	20 – 512	19 ± 2.0	0.4	22		50 – 100	SMT
C4-069	20 – 500	20 ± 2.0	0.5	20	1.4:1	20	SMT
C4-069	500 – 1000	20 ± 2.0	0.6	15	1.4:1	15	SMT
C4-077	20 – 1000	15 ± 2.0	0.7	15		50	SMT
C4-40-400-S-100	20 – 400	40 ± 2.0	0.3	20	1.4:1	100	SMT
DD4-082	20 – 305	40 ± 1.0	0.85	18	1.4:1	50 – 100	SMT
DD4-20-003-N-100	20 – 500	20 ± 2.0	0.3	18		100	N
DD4-30-125-N-50	5 – 150	30 ± 0.25	0.3	30	1.4:1	50	N
DD4-100-512-S-100	100 - 512	40 ± 1.0	0.02	20		100 CWC 500 W Peak	SMA

Quadrature Hybrids 90°
Vector Modulators (I&Q)
Phase Comparators / I&Q Demodulators
Quadrature Phase Detectors

I.F. ENGINEERING
PD-24006-S-RE
OUFA1

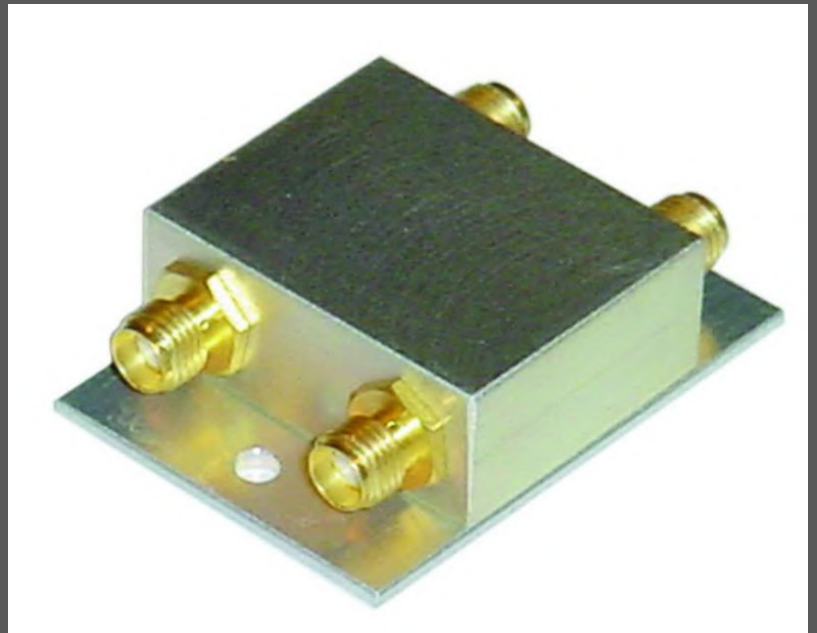

Quadrature Hybrids 90°

Octave 4 Port

Part Number	Frequency (MHz)	Insertion		Amplitude Balance (± dB)	Phase Balance (±)	VSWR In / Out	Input Power (W)	Connector Type
		Loss (dB)	Isolation (dB)					
QH-10-S	7 – 14	0.50	25	0.75	2	1.3:1	3	SMA
QH-20-S	14 – 28	0.50	25	0.75	2	1.2:1	3	SMA
QH-60-S	40 – 80	0.50	25	0.75	2	1.2:1	3	SMA
QH-70-S	50 – 90	0.50	25	0.75	2	1.2:1	3	SMA
QH-150-S	100 - 200	0.75	20	0.75	2	1.3:1	3	SMA
QH-150-FP	100 - 200	0.75	20	0.75	2	1.3:1	3	Flat pack
QH-180-S	125 - 250	0.75	20	0.75	2	1.3:1	3	SMA
QH-300-S	225 - 400	0.75	20	0.75	2	1.3:1	3	SMA
QH-300-FP	225 - 400	0.75	20	0.75	2	1.3:1	3	Flat Pack
QH-750-FP	500 - 1000	0.50	18	1.00	3	1.3:1	3	SMA

Quadrature Hybrids 90°

Broadband 3 Port

Part Number	Frequency (MHz)	Insertion Loss (dB)	Isolation (dB)	Amplitude Balance (± dB)	Phase Balance (±)	VSWR In / Out	Input Power (W)	Connector Type
QH-20-200-S	20 – 200	1.25	25	0.50	4	1.4:1	3	SMA
QH-30-300-S	30 – 300	1.25	20	1.00	3	1.4:1	3	SMA
QH-50-500-S	50 – 500	1.5	20	0.75	7.5	1.6:1	3	SMA
QH-100-1000-S	100 – 1000	2.5	18	0.75	10.0	1.8:1	2	SMA
QH-100-1000-FP8	100 – 1000	2.5	18	0.75	10.0	1.8:1	2	Flat Pack

Vector Modulators (I&Q)

Vector Modulators (I&Q)

Part Number	Frequency (MHz)	Phase Range	Phase Accuracy @ Fc (\pm°)	Insertion Loss (dB)	Null Depth (dB)	VSWR In/Out	Connector Type
QPMX-15-S	10 – 20	0 – 360	5	15	40	1.8:1	SMA
QPMX-15-P	10 – 20	0 – 360	5	15	40	1.8:1	Thru Hole
QPMX-30-S	20 – 40	0 – 360	5	14	40	1.6:1	SMA
QPMX-30-P	20 – 40	0 – 360	5	14	40	1.6:1	Thru Hole
QPMX-60-S	40 – 80	0 – 360	5	14	40	1.6:1	SMA
QPMX-60-P	40 – 80	0 – 360	5	14	40	1.6:1	Thru Hole
QMPX-100-S	70 – 140	0 – 360	5	14	40	1.6:1	SMA
QPMX-100-P	70 – 140	0 – 360	5	14	40	1.6:1	Thru Hole
QPMX-150-S	100 – 200	0 – 360	3	15	40	1.5:1	SMA
QPMS-150-P	100 – 200	0 – 360	3	15	40	1.5:1	Thru Hole
QPMX-300-S	225 – 400	0 – 360	7	15	40	1.6:1	SMA
QPMX-300-P	225 – 400	0 – 360	7	15	40	1.6:1	Thru Hole
QPMX-500-S	475 - 525	0 – 360	7	15	30	1.8:1	SMA

Phase Comparators / I&Q Demodulators

Quadrature Phase Detectors

Part Number	Frequency (MHz)	Phase Range	Phase Accuracy @ Fc (\pm °)	Conversion Loss (dB)	Amplitude		Connector Type
					Balance (\pm °)	VSWR	
QPD-10-S	7 – 14	0 – 360	3	10	0.5	1.5:1	SMA
QPD-30-S	20 – 40	0 – 360	5	10	0.5	1.5:1	SMA
QPD-30-P	27 - 33	0 – 360	5	10	1.0	1.5:1	Thru Hole
QPD-30-FP2	27 - 33	0 – 360	5	10	1.0	1.5:1	Flat Pack
QPD-45-S	30 – 60	0 – 360	3	10	0.5	1.5:1	SMA
QPD-100-S	90 - 110	0 – 360	3	10	0.5	1.5:1	SMA
QPD-150-S	135 - 165	0 – 360	3	10	0.5	1.5:1	SMA
QDP-500-S	475 - 525	0 - 360	7	12	1.0	1.8:1	SMA

Phase Comparators / I&Q Demodulators

I&Q Demodulators

Part Number	Frequency (MHz)	Phase Range	Phase Accuracy @ Fc (\pm°)	Conversion Loss (dB)	Amplitude		Connector Type
					Balance (\pm°)	VSWR	
QIFM-30-S	20 – 40	0 – 360	5	10	0.5	1.5:1	SMA
QIFM-30-P	20 – 40	0 – 360	5	10	0.5	1.5:1	Thru Hole
QIFM-30-SM	20 – 40	0 – 360	5	10	0.5	1.5:1	Surface Mount
QIFM-30-FP2	20 – 40	0 – 360	5	10	0.5	1.5:1	Flat Pack
QIFM-45-S	30 – 55	0 – 360	5	10	0.5	1.5:1	SMA
QIFM-45-P	30 – 55	0 – 360	5	10	0.5	1.5:1	Thru Hole
QIFM-45-SM	30 – 55	0 – 360	5	10	0.5	1.5:1	Surface Mount
QIFM-45-FP2	30 – 55	0 – 360	5	10	0.5	1.5:1	Flat Pack
QIFM-60-S	50 – 70	0 – 360	5	10	0.5	1.5:1	SMA
QIFM-60-P	50 – 70	0 – 360	5	10	0.5	1.5:1	Thru Hole
QIFM-60-SM	50 – 70	0 – 360	5	10	0.5	1.5:1	Surface Mount
QIFM-60-FP2	50 – 70	0 – 360	5	10	0.5	1.5:1	Flat Pack
QIFM-160-S	135 - 185	0 – 360	10	10	0.5	1.6:1	SMA
QIFM-160-P	135 - 185	0 – 360	10	10	0.5	1.6:1	Thru Hole
QIFM-160-SM	135 - 185	0 – 360	10	10	0.5	1.6:1	Surface Mount
QIFM-160-FP2	135 - 185	0 – 360	10	10	0.5	1.6:1	Flat Pack
QIFM-500-S	475 - 525	0 – 360	7	12	1.0	1.8:1	SMA
QIFM-1000-SM	950 – 1050	0 – 360	10	12	1.0	2.0:1	SMA

Multi-Couplers and Distribution Amplifiers

I.F. ENGINEERING
PD-24006-S-RE
OUFA1



Multi-Couplers / Distribution Amplifiers

Product Overview

I.F. Engineering Multi-Couplers provide a reliable, cost effective Product for the distribution of signals. Our Multi-Couplers have a proven track record for continuous operation providing excellent Gain flatness across the entire frequency range. We offer standard configurations as noted below, but our specialty is providing uniquely engineered products that will meet your specific needs.



Product Features / Options

- Excellent Gain Flatness
- 0.5 – 32 MHz: HF
- 20 MHz – 525 MHz: VHF
- 950 MHz – 2150 MHz: LB3
- 20 MHz – 3000 MHz: VHF/UHF
- 0.5 MHz – 18 GHz: MW
- 50Ω or 75Ω Mixed
- Universal Redundant Power Supplies
- Monitors Front or Rear Panel
- Switchable & Fused LNB
- Passive or Unity Gain

Input Ports	Output Ports /Input Port	Size
1	8	1 RU
1	16	1 RU
1	32	2 RU
2	8	1 RU
2	16	2 RU
4	8	2 RU
8	4	2 RU

Specifying Multi-Coupler

MC-4 x 32-LB1-B-75-1

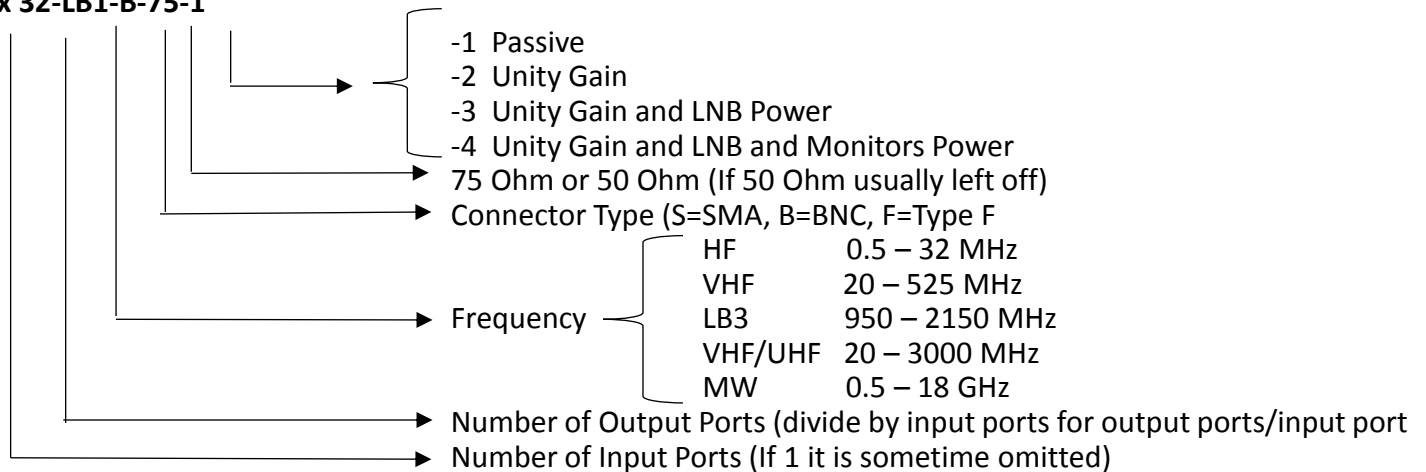

Other Considerations:

- Input Ports on Front or Rear Panel
- Output Ports on Front or Rear Panel
- Monitor Ports on Front or Rear Panel

Multi-Couplers / Distribution Amplifiers

L-Band Multi-Coupler – 75 Ohms

Part Number	Frequency (MHz)	Gain (dB)	Port to Port		Input Ports – Output Ports per		Impedance (Ohms)
			Isolation (dB)	VSWR Input / Output	Input		
MC-16 LB3-75	950 – 2150	0 ± 2.0	18 typ.	2.0:1 / 1.8:1 Max	1 – 16	75	
MC-32-LB3-75	950 – 2150	0 ± 2.0	18 typ.	2.0:1 / 1.8:1 Max	1 – 32	75	
MC-2X16-LB3-75	950 – 2150	0 ± 2.0	18 typ.	2.0:1 / 1.8:1 Max	2 – 8	75	
MC-2X32-LB3-75	950 – 2150	0 ± 2.0	18 typ.	2.0:1 / 1.8:1 Max	2 – 16	75	
MC-4X32-LB3-75	950 – 2150	0 ± 2.0	18 typ.	2.0:1 / 1.8:1 Max	4 – 8	75	
MC-8X32-LB3-75	950 – 2150	0 ± 2.0	18 typ.	2.0:1 / 1.8:1 Max	8 – 4	75	

Connectors Type F or BNC
 Additional Options RF Monitor Port
 LNB Power
 Uplink Combiner

L-Band Multi-Coupler – 50 Ohms

Part Number	Frequency (MHz)	Gain (dB)	Port to Port		Input Ports – Output Ports per		Impedance (Ohms)
			Isolation (dB)	VSWR Input / Output	Input		
MC-16 LB3-50	950 – 2150	0 ± 2.0	18 typ.	2.0:1 / 1.8:1 Max	1 – 16	50	
MC-32-LB3-50	950 – 2150	0 ± 2.0	18 typ.	2.0:1 / 1.8:1 Max	1 – 32	50	
MC-2X16-LB3-50	950 – 2150	0 ± 2.0	18 typ.	2.0:1 / 1.8:1 Max	2 – 8	50	
MC-2X32-LB3-50	950 – 2150	0 ± 2.0	18 typ.	2.0:1 / 1.8:1 Max	2 – 16	50	
MC-4X32-LB3-50	950 – 2150	0 ± 2.0	18 typ.	2.0:1 / 1.8:1 Max	4 – 8	50	
MC-8X32-LB3-50	950 – 2150	0 ± 2.0	18 typ.	2.0:1 / 1.8:1 Max	8 – 4	50	

Connectors Type F or BNC
 Additional Options RF Monitor Port
 LNB Power
 Uplink Combiner

Multi-Couplers / Distribution Amplifiers

IF-Band Multi-Coupler

Part Number	Frequency (MHz)	Gain (dB)	Port to Port		VSWR Input / Output	Input Ports – Output Ports per Input	Impedance (Ohms)
			Isolation (dB)				
MC-16-IF-75	20 – 200	0 ± 2.0	30 typ.		1.75:1 / 1.5:1 Max	1 – 16	75
MC-32-IF-75	20 – 200	0 ± 2.0	30 typ.		1.75:1 / 1.5:1 Max	1 – 32	75
MC-2X16-IF-75	20 – 200	0 ± 2.0	30 typ.		1.75:1 / 1.5:1 Max	2 – 8	75
MC-2X32-IF-75	20 – 200	0 ± 2.0	30 typ.		1.75:1 / 1.5:1 Max	2 – 16	75
MC-4X32-IF-75	20 – 200	0 ± 2.0	30 typ.		1.75:1 / 1.5:1 Max	4 – 8	75
MC-8X32-IF-75	20 – 200	0 ± 2.0	30 typ.		1.75:1 / 1.5:1 Max	8 – 4	75
MC-16-IF-50	20 – 200	0 ± 2.0	30 typ.		1.75:1 / 1.5:1 Max	1 – 16	50
MC-32-IF-50	20 – 200	0 ± 2.0	30 typ.		1.75:1 / 1.5:1 Max	1 – 32	50
MC-2X16-IF-50	20 – 200	0 ± 2.0	30 typ.		1.75:1 / 1.5:1 Max	2 – 8	50
MC-2X32-IF-50	20 – 200	0 ± 2.0	30 typ.		1.75:1 / 1.5:1 Max	2 – 16	50
MC-4X32-IF-50	20 – 200	0 ± 2.0	30 typ.		1.75:1 / 1.5:1 Max	4 – 8	50
MC-8X32-IF-50	20 – 200	0 ± 2.0	30 typ.		1.75:1 / 1.5:1 Max	8 – 4	50

HF-Band Multi-Coupler

Part Number	Frequency (MHz)	Gain (dB)	Port to Port		VSWR Input / Output	Noise Figure	Input Ports – Output Ports per Input	Impedance (Ohms)
			Isolation (dB)					
MC-16-HF-50	0.5 – 32	0 ± 2.0	35 typ.		1.5:1 / 1.5:1 Max	6.0	1 – 16	50
MC-32-HF-50	0.5 – 32	0 ± 2.0	35 typ.		1.5:1 / 1.5:1 Max	6.0	1 – 32	50
MC-2X16-HF-50	0.5 – 32	0 ± 2.0	35 typ.		1.5:1 / 1.5:1 Max	8.5	2 – 8	50
MC-2X32-HF-50	0.5 – 32	0 ± 2.0	35 typ.		1.5:1 / 1.5:1 Max	6.0	2 – 16	50
MC-4X32-HF-50	0.5 – 32	0 ± 2.0	35 typ.		1.5:1 / 1.5:1 Max	8.5	4 – 8	50

VHF / UHF-Band Multi-Coupler

Part Number	Frequency	Gain (dB)	Port to Port		VSWR Input / Output	Input Ports – Output Ports per Input	Impedance (Ohms)
			Isolation (dB)				
MC-16-VHF/UHF-50	30 MHz – 3 GHz	0 ± 2.0	18 typ.		2.0:1 / 1.8:1 Max	1 – 16	50
MC-32-VHF/UHF-50	30 MHz – 3 GHz	0 ± 2.0	18 typ.		2.0:1 / 1.8:1 Max	1 – 32	50
MC-2X16-VHF/UHF-50	30 MHz – 3 GHz	0 ± 2.0	18 typ.		2.0:1 / 1.8:1 Max	2 – 8	50
MC-2X32-VHF/UHF-50	30 MHz – 3 GHz	0 ± 2.0	18 typ.		2.0:1 / 1.8:1 Max	2 – 16	50
MC-4X32-VHF/UHF-50	30 MHz – 3 GHz	0 ± 2.0	18 typ.		2.0:1 / 1.8:1 Max	4 – 8	50
MC-8X32-VHF/UHF-50	30 MHz – 3 GHz	0 ± 2.0	18 typ.		2.0:1 / 1.8:1 Max	8 – 4	50

Ordering Information

At I.F. Engineering Corp you are not limited to the products in this catalog, as it is intended to be used as a guide in selecting components or switch matrices for a given application. Requests for modifications of standard items and their specifications in order to meet specific needs are our business. As we proudly state, *Your Challenge is Our Progress.*

The catalog is subject to change without notification at any time and new product information is constantly being added to our websites at www.ifengineering.com and www.crosspointtechnologies.com. Please visit the websites to request quotations, download product information, find a listing of our manufacturer's representatives and company contact information.

Ordering

Information found in this catalog or on our websites should be sufficient to select a particular product. In rare cases where additional information is required, contact I.F. Engineering Corp directly or your local manufacturer's representative.

When placing your order, please include the part number, product name, quantity, quotation number and shipping instructions. In the case of a custom product, a full description of the desired features must accompany the order to avoid errors. Send orders to your manufacturer's representative or direct to:

I.F. Engineering Corp
3 Foshay Road
Dudley, MA 01571 USA

Order Acknowledgements will be processed via any of the following methods; U.S. mail, telephone, fax, or email.

Domestic Terms

Net 30 days, F.O.B. I.F. Engineering Corp, Dudley, MA, USA unless otherwise specified. Shipment are made to customers on a C.O.D. basis unless credit terms have been established or on receipt of advanced payment.

Export Terms

Unless other terms have been agreed to in advance, export terms are either payment in advance of shipment or against a confirmed irrevocable Letter of Credit. All prices are F.O.B. Dudley, MA USA.

Shipping

Orders within the United States and Canada will be shipped United Parcel Service Ground unless other instructions are received. Shipment to all other countries will be by the customer's direction.

Packaging

All products shipped from I.F. Engineering Corp Dudley, MA USA are packaged in accordance with best commercial practices unless otherwise specified in the contract or purchase order.

Delivery

Numbers of our products ship from stock. Other products require a manufacturing lead-time of 1 to 10 weeks after receipt of order (ARO) plus transit time.

Source Inspection

Should Customer Source Inspection (CSI) be required, the cost of this service will be quoted in advance and it shall appear as a separate line item on the contract or purchase order.

Application and Technical Assistance

I.F. Engineering Corp provides a knowledgeable and experienced engineering staff to work closely with our customers during product design and application development in addition to minor modifications to standard products. This service is also available for the design of individual components or complex switching systems.

Warranty

Unless stated otherwise I.F. Engineering Corp warrants all products to be free of defects in material and workmanship for a period of two years after the date of initial shipment. The limit of liability under this warranty is to repair, replace or refund the purchase price of any part of product thereof that is returned by the original purchaser and proves to be defective after examination by I.F. Engineering Corp. This warranty does not extend to any products mishandled, misused, or subjected to abuse or neglect in storage, transportation or use. Repairs or alterations made without consent or knowledge of I.F. Engineering Corp will invalidate this warranty. This warranty supersedes all others, either expressed or implied.

Return Material Authorization (RMA)

Please contact I.F. Engineering to receive a Return Material Authorization (RMA) number prior to returning any part or product for service. Items returned to I.F. Engineering Corp without a RMA number are subject to return without evaluation or any work being performed. I.F. Engineering Corp will not accept C.O.D. freight charges for returned parts or products.

I.F. Engineering Corp Terms and Conditions

I.F. Engineering Corp Terms and Conditions apply to all orders unless other provisions have been previously agreed upon. A copy of I.F. Engineering Corp's Terms and Conditions can be found at www.ifengineering.com.

Certificate of Compliance

If requested at the time an award is received, a Certificate of Compliance will be provided when the part or product shipment takes place.

Minimum Order Value

The I.F. Engineering Corp minimum order value is \$300.00 USD.

Product Changes

I.F. Engineering Corp continually improves products as new technologies, materials, and processes become available. We, therefore, reserve the right to alter, amend, discontinue, or replace any product and or specifications in this catalog at our sole discretion without prior notice.