

GaAs MMIC Double Balanced Mixer

MM1-0832LSM

1. Device Overview

1.1 General Description

The MM1-0832LSM is a GaAs MMIC double balanced mixer that is optimized for high frequency applications. MM1-0832LSM is a high frequency X band mixer that works well as both an up and down converter through Ka band. This mixer offers low conversion loss and high LO to RF isolations at low LO powers. The sister MM1-0832HSM is recommended for medium power applications. The MM1-0832LSM is available in a 3x3 mm QFN package. Evaluation boards are available.

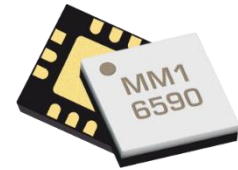

3 x 3 mm
QFN

1.2 Features

- High IF frequency
- RoHS Compliant

1.3 Applications

- Test and measurement equipment
- Electronic Warfare
- 5G
- SATCOM

1.4 Functional Block Diagram

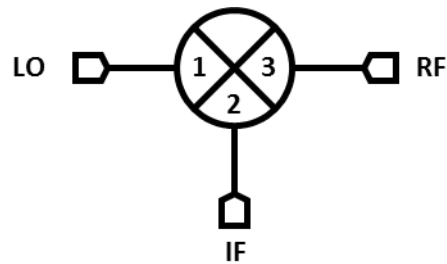

1.5 Part Ordering Options¹

Part Number	Description	Package	Green Status	Product Lifecycle	Export Classification
MM1-0832LSM-2	3x3 mm QFN	SM	RoHS	Active	EAR99
EVAL-MM1-0832L	Connectorized Evaluation Fixture	Eval		Active	EAR99

¹ Refer to our [website](#) for a list of definitions for terminology presented in this table.

Table of Contents

1. Device Overview	1	3.6 Typical Performance Plots	6
1.1 General Description	1	3.6.1 Typical Performance Plots: IP3 ..	8
1.2 Features	1	3.6.2 Typical Performance Plots: LO	
1.3 Applications	1	Harmonic Isolation.....	9
1.4 Functional Block Diagram	1	3.6.3 Typical Spurious Performance:	
1.5 Part Ordering Options.....	1	Down-Conversion	10
2. Port Configurations and Functions	3	3.6.4 Typical Spurious Performance: Up-	
2.1 Port Diagram	3	Conversion	10
2.2 Port Functions	3	4. Operation.....	11
3. Specifications	4	4.1 Application Circuit	11
3.1 Absolute Maximum Ratings.....	4	4.2 Ports Operation	11
3.2 Package Information	4	5. Mechanical Data	12
3.3 Recommended Operating Conditions .	4	5.1 SM Package Outline Drawing	12
3.4 Sequencing Requirements	4	5.2 SM Package Footprint	12
3.5 Electrical Specifications	5	5.3 Evaluation Board Outline Drawing...	12

Revision History

Revision Code	Revision Date	Comment
-	January 2019	Datasheet Initial Release



2. Port Configurations and Functions

2.1 Port Diagram

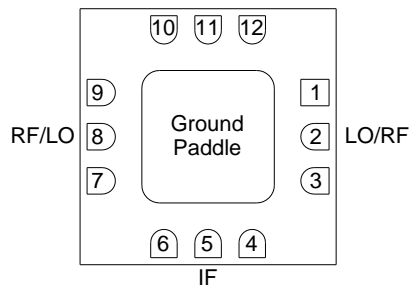
A bottom-up view of the MM1-0832LSM's SM package outline drawing is shown below. The MM1-0832LSM has the input and output ports given in Port Functions. The MM1-0832LSM can be used in either an up or down conversion. For configuration A, input the LO into pin 2, use pin 8 for the RF, and pin 5 for the IF. For configuration B, input the LO into pin 8, use pin 2 for the RF, and pin 5 for the IF.

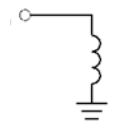
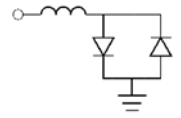

2.2 Port Functions

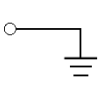
Port	Function	Description	Equivalent Circuit for Package
Pin 2	LO (Configuration A) RF (Configuration B)	Pin 2 is DC short and AC matched to 50 Ohms from 8 to 32 GHz. Blocking capacitor is optional.	
Pin 5	IF	Pin 5 is DC coupled to the diodes. Blocking capacitor is optional.	
Pin 8	RF (Configuration A) LO (Configuration B)	Pin 8 is DC open and AC matched to 50 Ohms from 8 to 32 GHz.	
GND	Ground	SM package ground path is provided through the ground paddle.	GND 

3. Specifications

3.1 Absolute Maximum Ratings

The Absolute Maximum Ratings indicate limits beyond which damage may occur to the device. If these limits are exceeded, the device may be inoperable or have a reduced lifetime.

Parameter	Maximum Rating	Units
Pin 2 DC Current	30	mA
Pin 5 DC Current	15	mA
Power Handling, at any Port	+28	dBm
Operating Temperature	-55 to +100	°C
Storage Temperature	-65 to +125	°C

3.2 Package Information

Parameter	Details	Rating
ESD	Human Body Model (HBM), per MIL-STD-750, Method 1020	1A
Weight	EVAl package	13.4 g

3.3 Recommended Operating Conditions

The Recommended Operating Conditions indicate the limits, inside which the device should be operated, to guarantee the performance given in Electrical Specifications. Operating outside these limits may not necessarily cause damage to the device, but the performance may degrade outside the limits of the electrical specifications. For limits, above which damage may occur, see Absolute Maximum Ratings.

	Min	Nominal	Max	Units
T _A , Ambient Temperature	-55	+25	+100	°C
LO Input Power	+8		+15	dBm

3.4 Sequencing Requirements

There is no requirement to apply power to the ports in a specific order. However, it is recommended to provide a 50Ω termination to each port before applying power. This is a passive diode mixer that requires no DC bias.

3.5 Electrical Specifications

The electrical specifications apply at $T_A = +25^\circ\text{C}$ in a 50Ω system. Typical data shown is for a down conversion application with a +12dBm sine wave LO input. Specifications shown for configuration A (B).

Parameter		Test Conditions	Min	Typical	Max	Units
RF (Pin 8) Frequency Range			8		32	GHz
LO (Pin 2) Frequency Range			8		30	
I (Pin 5) Frequency Range			0		12	
Conversion Loss (CL) ²		RF/LO = 8 - 30 GHz I = DC - 0.2 GHz		7.5 (9)	10.5 (12)	dB
		RF/LO = 8-30 GHz I = 0.2 - 12 GHz		8.5 (10.5)		
Noise Figure (NF) ³		RF/LO = 8-30 GHz I = DC - 0.2 GHz		9		dB
Isolation	LO to RF	RF/LO = 8 - 32 GHz		36		dB
	LO to IF	IF/LO = 8 - 32 GHz		23		
	RF to IF	RF/IF = 8 - 32 GHz		23		
Input IP3 (IIP3)		RF/LO = 8 - 30 GHz I = DC - 0.2 GHz		+11 (+14)		dBm
Input 1 dB Gain Compression Point (P1dB)				+2 (+4)		dBm

² Measured as a down converter to a fixed 91MHz IF.

³ Mixer Noise Figure typically measures within 0.5 dB of conversion loss for IF frequencies greater than 5 MHz.

3.6 Typical Performance Plots

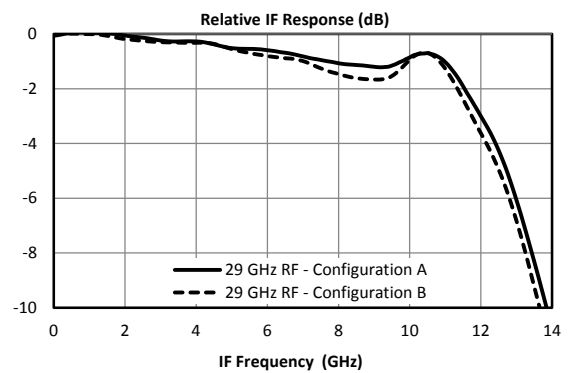
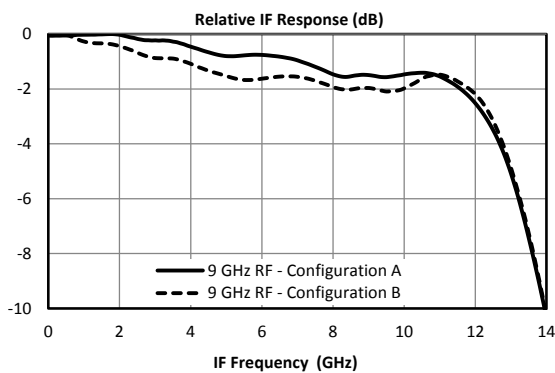
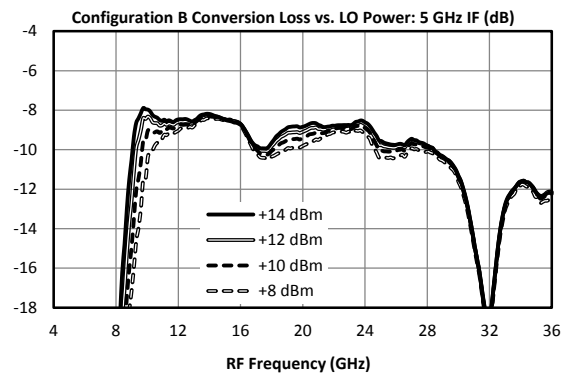
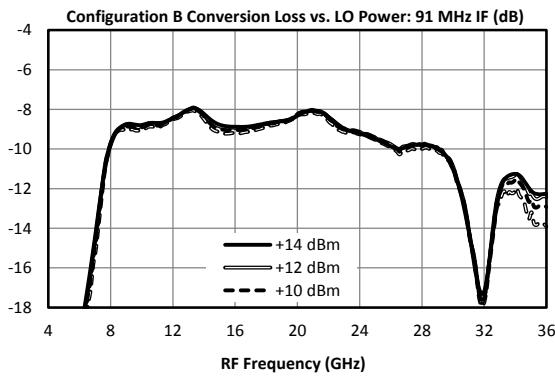
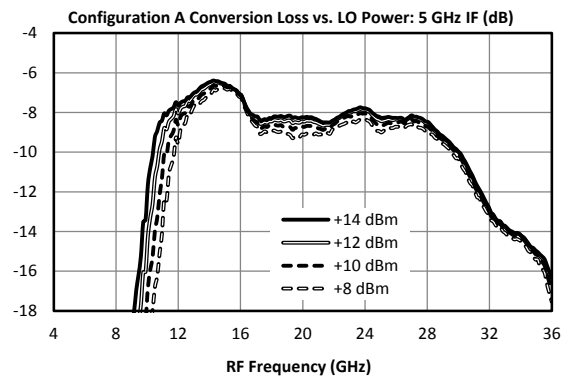
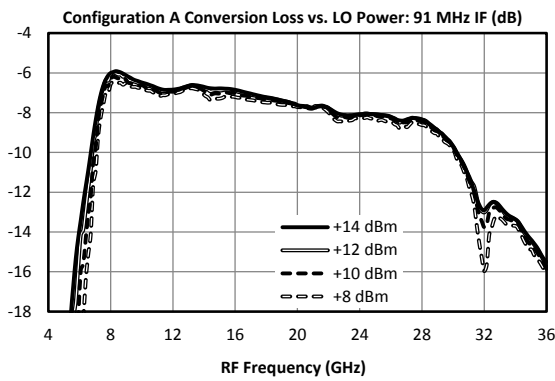
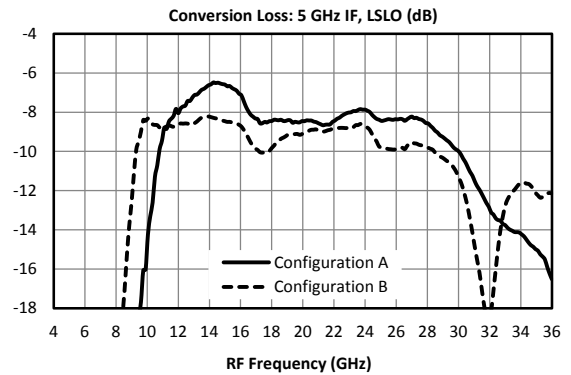
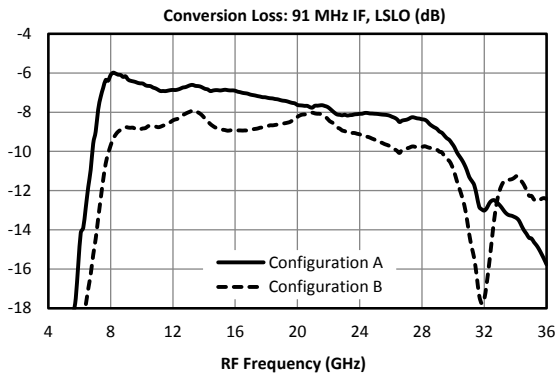

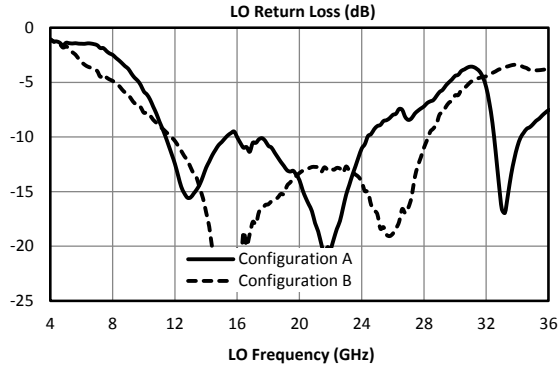
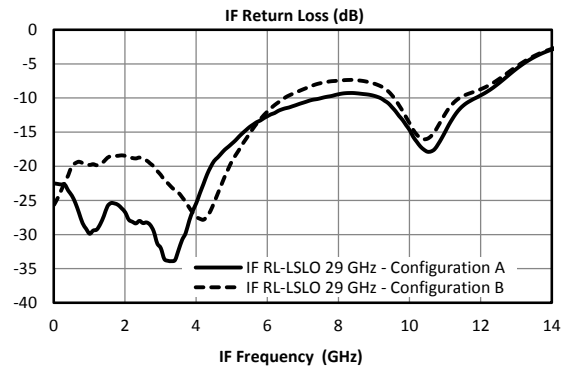
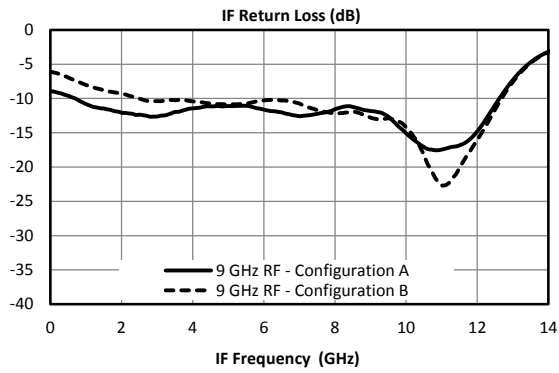
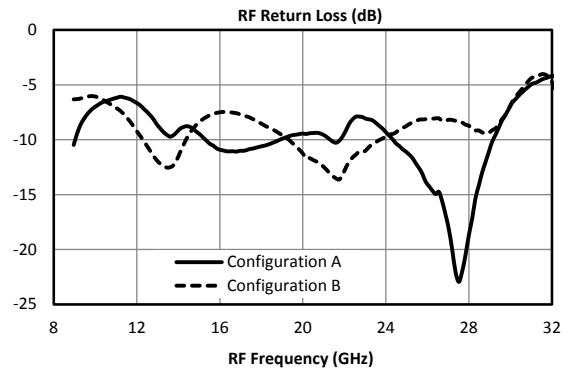
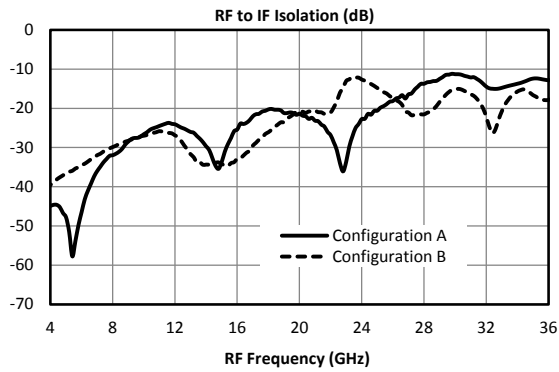
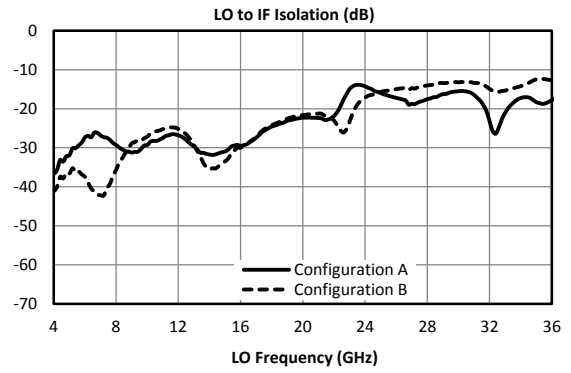
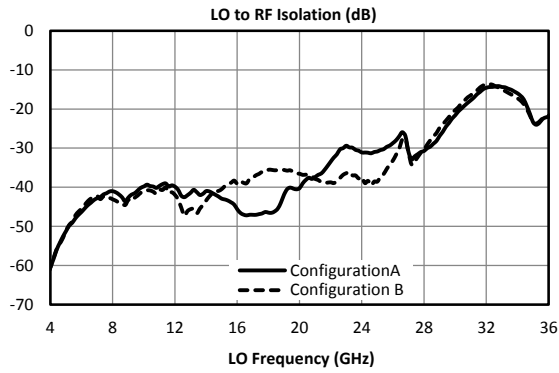

3.6.1 Typical Performance Plots: IP3

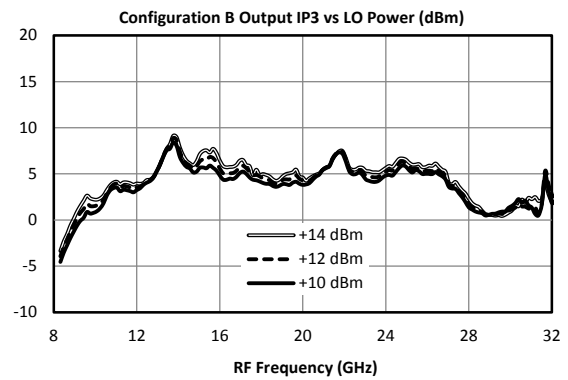
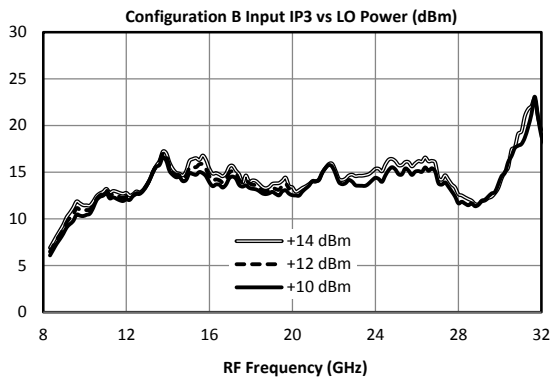
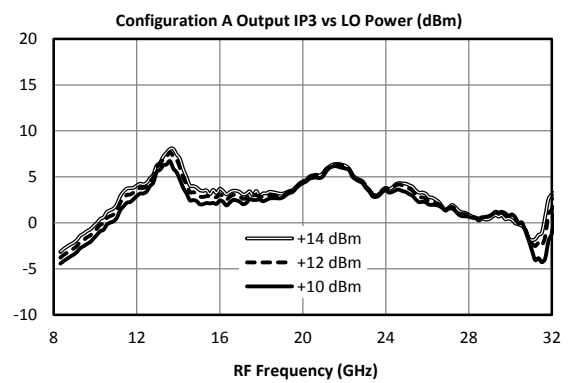
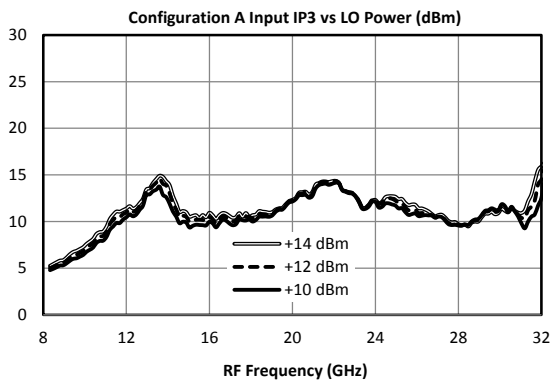
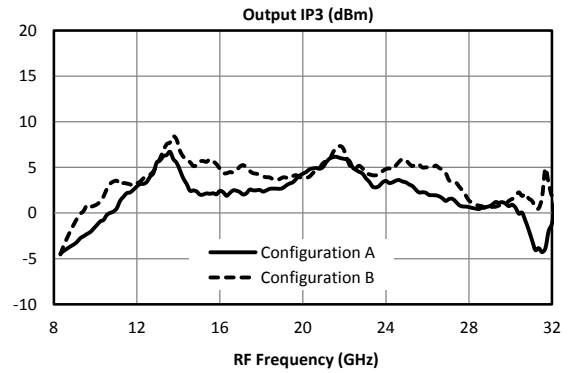
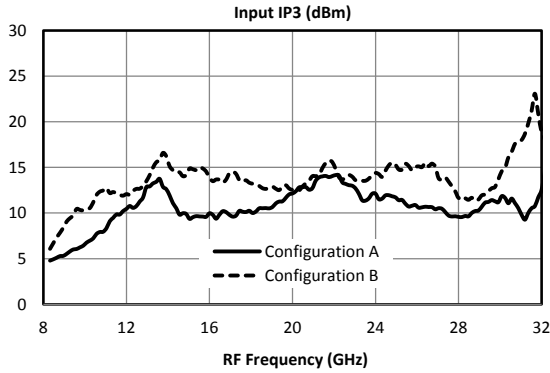

3.6.2 Typical Performance Plots: LO Harmonic Isolation

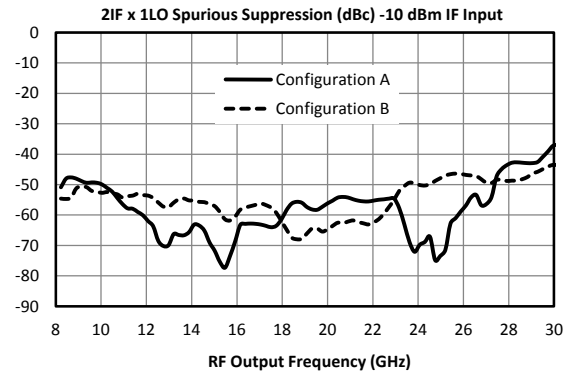
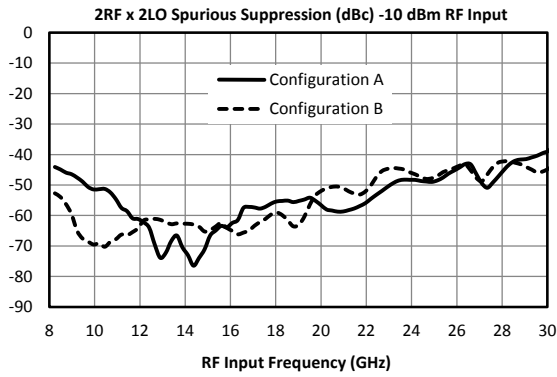
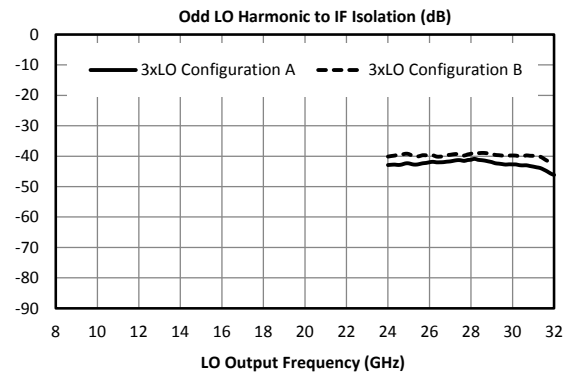
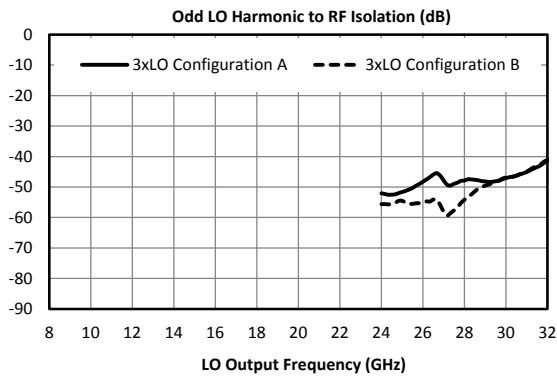
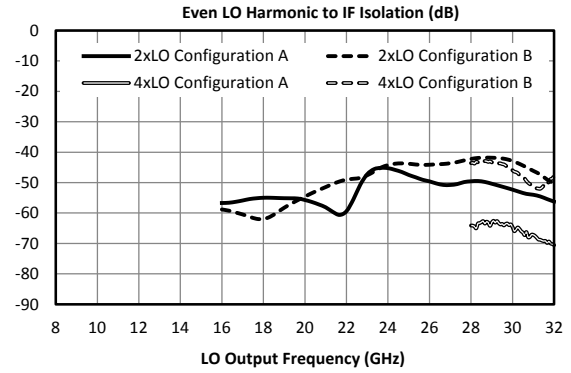
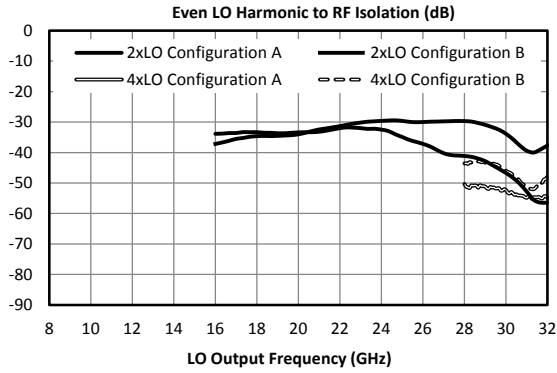

3.6.3 Typical Spurious Performance: Down-Conversion

Typical spurious data is provided by selecting RF and LO frequencies ($\pm m \cdot LO \pm n \cdot RF$) within the RF/LO bands, to create a spurious output within the IF band. The mixer is swept across the full spurious band and the mean is calculated. The numbers shown in the table below are for a -10 dBm RF input. Spurious suppression is scaled for different RF power levels by $(n-1)$, where “n” is the RF spur order. For example, the $2RF \times 2LO$ spur is 53 dBc for a -10 dBm input, so a -20 dBm RF input creates a spur that is $(2-1) \times (-10 \text{ dB})$ lower, or 63 dBc. Data is shown for the frequency plan in 3.6 Typical Performance. $mLO \times nRF$ plots can be found in section 3.6.2 Typical Performance Plots: LO Harmonic Isolation. $0LO \times 1RF$ plot is identical to the plot of LO-RF isolation.

Typical Down-conversion spurious suppression (dBc): Config A (B)

-10 dBm RF Input	0xLO	1xLO	2xLO	3xLO	4xLO	5xLO
0xRF	-	22 (23)	38 (33)	48 (51)	53 (47)	61 (58)
1xRF	16 (11)	Reference	33 (37)	13 (14)	45 (41)	41 (26)
2xRF	62 (65)	54 (39)	53 (54)	54 (44)	58 (63)	51 (49)
3xRF	58 (65)	46 (47)	67 (79)	56 (58)	65 (77)	55 (60)
4xRF	94 (89)	86 (80)	76 (84)	90 (82)	88 (94)	92 (85)
5xRF	94 (101)	87 (82)	90 (93)	92 (100)	100 (108)	97 (99)

3.6.4 Typical Spurious Performance: Up-Conversion

Typical spurious data is taken by mixing an input within the IF band, with LO frequencies ($\pm m \cdot LO \pm n \cdot IF$), to create a spurious output within the RF output band. The mixer is swept across the full spurious output band and the mean is calculated. The numbers shown in the table below are for a -10 dBm IF input. Spurious suppression is scaled for different IF input power levels by $(n-1)$, where “n” is the IF spur order. For example, the $2IF \times 1LO$ spur is typically 57 dBc for a -10 dBm input with a sine-wave LO, so a -20 dBm IF input creates a spur that is $(2-1) \times (-10 \text{ dB})$ lower, or 67 dBc. Data is shown for the frequency plan in 3.6 Typical Performance.

Typical Up-conversion spurious suppression (dBc): Config A (B)

-10 dBm RF Input	0xLO	1xLO	2xLO	3xLO	4xLO	5xLO
0xIF	-	51 (50)	53 (49)	43 (40)	66 (56)	57 (49)
1xIF	24 (21)	Reference	37 (39)	15 (15)	38 (39)	35 (33)
2xIF	71 (52)	57 (54)	46 (35)	51 (60)	56 (46)	50 (49)
3xIF	83 (90)	54 (55)	61 (69)	49 (42)	64 (77)	58 (63)
4xIF	100 (90)	88 (94)	87 (73)	87 (94)	73 (73)	89 (94)
5xIF	108 (114)	90 (91)	97 (104)	87 (77)	96 (106)	80 (84)

4. Operation

4.1 Application Circuit

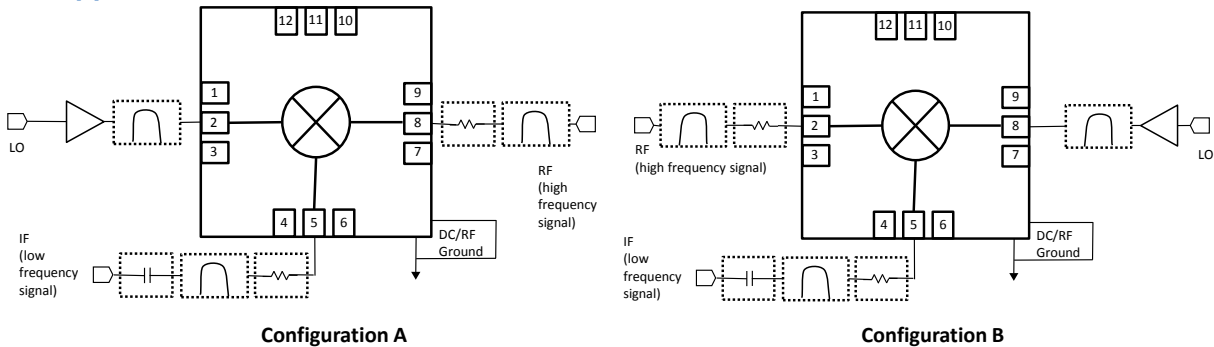

4.2 Ports Operation

IF Port – Used as input on an upconversion, output on downconversion, or LO port in a band shifting application. Signals should be connected by 50 ohm microstrip or coplanar traces to well matched broadband 50 ohm sources and loads. Blocking capacitor is recommended if DC voltage is present on the line.

RF Port – Used as input on a downconversion, output on upconversion, or output in a band shifting application. Signals should be connected by 50 ohm microstrip or coplanar traces to well matched broadband 50 ohm sources and loads.

Filtering and Matching- Filtering is generally desired for spurious and image removal on the output port of the mixer. Reflective filters can cause out of band signals to reflect back into the mixer and cause conversion loss ripple, erroneous spurs, and other undesired behaviors. To eliminate these problems it is recommended that the filters be placed as close to the output port as possible. If undesired behavior is still observed, a diplexer with one port terminated or a 1-3 dB attenuator may reduce this problem.

RF Ground – The ground paddle of the QFN should be connected to a low noise RF ground with very low electrical resistance for high frequency operation.

LO Port – The noise floor of the LO input signal should be less than the value of the noise floor plus isolation of the mixer, or a filter is recommended to prevent reduction in dynamic range. An LO amplifier is required if the LO power is below the recommended drive level. It is important to use an amplifier with a broadband 50 ohm match such that it does not reflect spurious signals back into the mixer or other system circuitry.

5. Mechanical Data

5.1 SM Package Outline Drawing

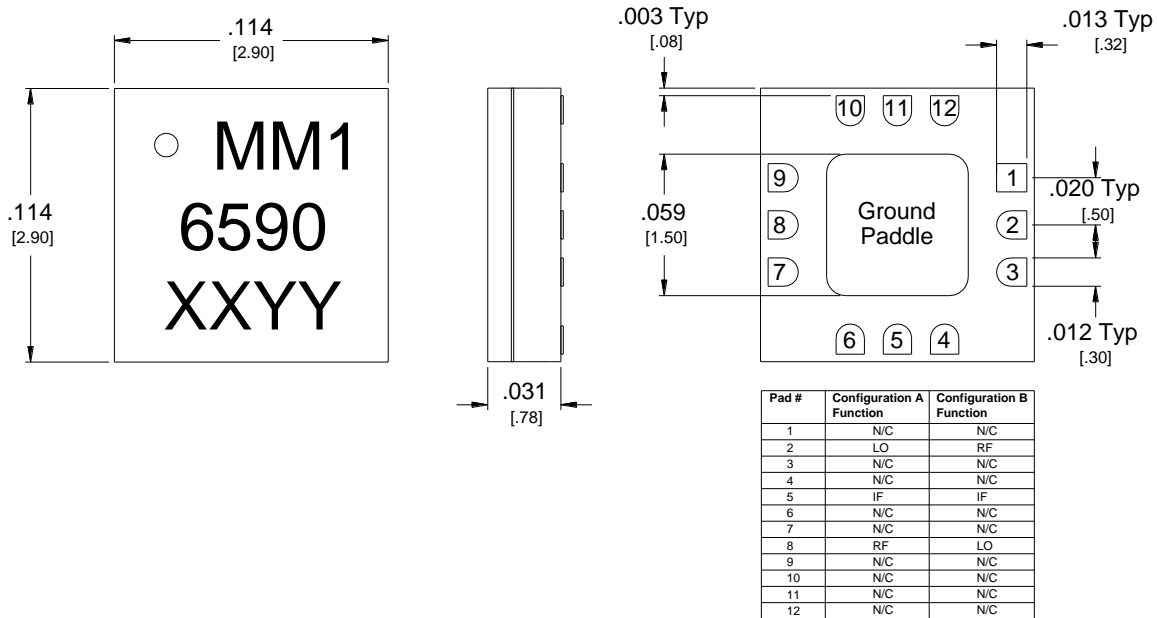

- Substrate material is ceramic.
- I/O Leads and Ground Paddle plating is (from base to finish):
 - Ni: 8.89um MAX 1.27um MIN
 - Pd: 0.17um MAX 0.07um MIN
 - Au 0.254um MAX 0.03um MIN
- All unconnected pads should be connected to PCB RF ground.

5.2 SM Package Footprint

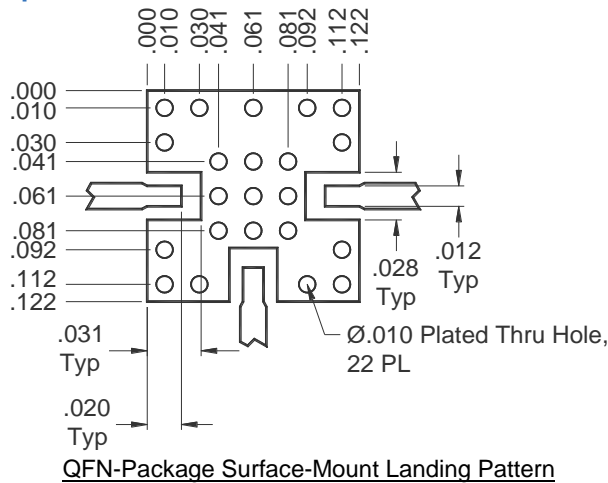

[Click here for a DXF of the above layout.](#)

[Click here for leaded solder reflow.](#) [Click here for lead-free solder reflow.](#)

5.3 Evaluation Board Outline Drawing

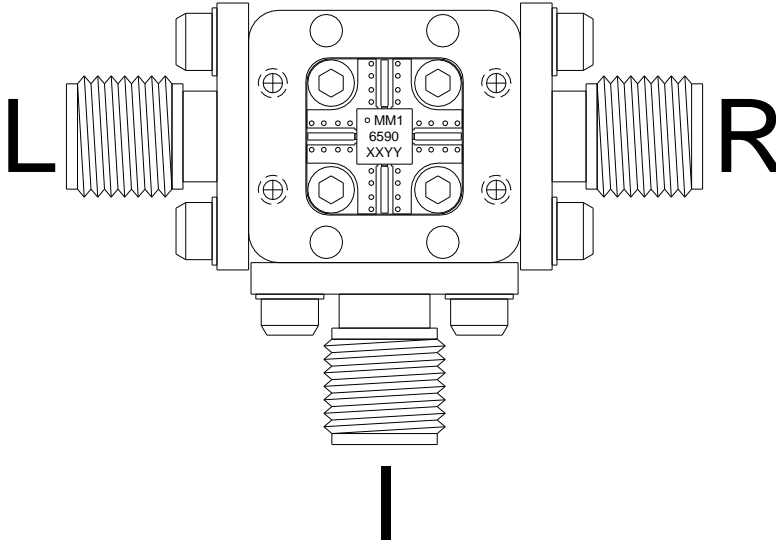

Port	Connector Type
LO	2.92 mm Female
RF	2.92 mm Female
IF	SMA Female
Note: Eval Connectors are not removeable.	

Marki Microwave reserves the right to make changes to the product(s) or information contained herein without notice.

Marki Microwave makes no warranty, representation, or guarantee regarding the suitability of its products for any particular purpose, nor does Marki Microwave assume any liability whatsoever arising out of the use or application of any product.