



MICROLITHIC™ DOUBLE-BALANCED MIXER

ML1-0626SM

The ML1-0626SM is a Surface Mount Microlithic™ double balanced mixer. As with all Microlithic™ mixers, it features excellent conversion loss, isolation, and spurious performance across a broad bandwidth and in a miniaturized form factor. Accurate, nonlinear software models are available for Microwave Office through the Marki Microwave PDK. The ML1-0626SM is a lead free, RoHS compliant package compatible with standard leaded and lead-free solder reflows. SMA connectorized evaluation packages are available. The ML1-0626SM is an excellent alternative to Marki Microwave M1 and M3 mixers packaged in surface mount packages such as the EZ package.



Features

- Compact SMT Style Package (0.152" x 0.090"x0.045")
- CAD Optimized for Superior Isolation and Spurious Response
- Broadband Performance
- Excellent Unit-to-Unit Repeatability
- Wire Bondable Chip Alternatives: [ML1-0638](#)
- Fully nonlinear software models available with Marki PDK for Microwave Office
- RoHS Compliant

Mixer Line	Suitable Alternative for Models
M1	M1-0616, M1-0818, M1-1020

Electrical Specifications - Specifications guaranteed from -55 to +100°C, measured in a 50Ω system.

Parameter	LO (GHz)	RF (GHz)	IF (GHz)	Min	Typ	Max	Diode Option ¹ LO drive level (dBm)	
Conversion Loss (dB)	6-26		DC-8		7.5	12.5		
Isolation (dB)						See Plots		
LO-RF								
LO-IF								
RF-IF								
Input 1 dB Compression (dBm)					+3 +9		L (+10 to +13) I (+15 to +19)	
Input Two-Tone Third Order Intercept Point (dBm)					+14 +21		L (+10 to +13) I (+15 to +19)	

¹Contact factory for other diode options.

Part Number Options

Model Number	Description
ML1-0626LSM-2	Surface Mount, L-Diode, I Port Configuration -2
ML1-0626ISM-2	Surface Mount, I-Diode, I Port Configuration -2
EVAL-ML1-0626LSM	Connectorized Evaluation Fixture, L-Diode
EVAL-ML1-0626ISM	Connectorized Evaluation Fixture, I-Diode

MICROLITHIC™ DOUBLE-BALANCED MIXER

ML1-0626SM

Page 2

LO/RF 6 to 26 GHz
IF DC to 8 GHz

Typical Performance

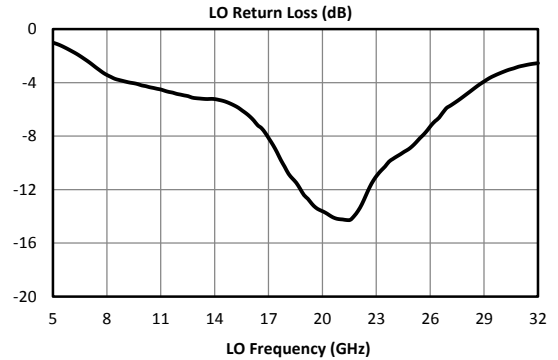
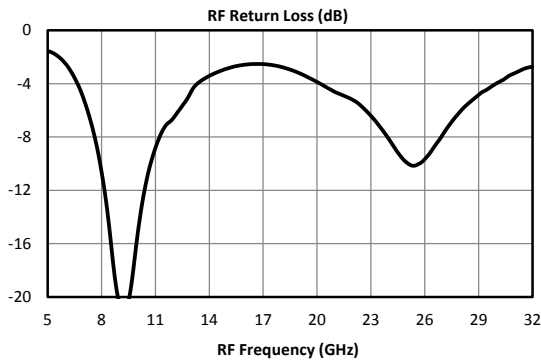
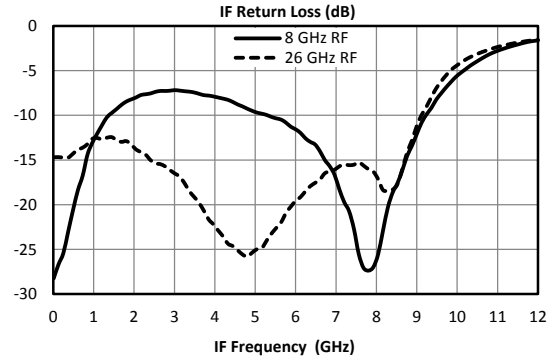
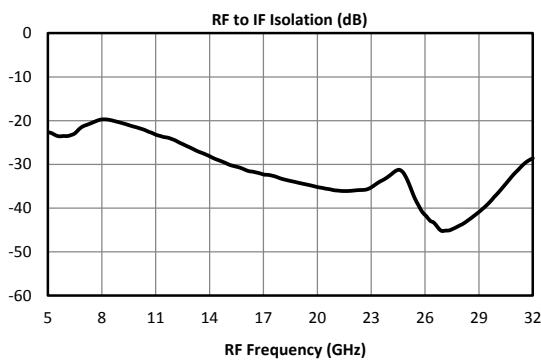
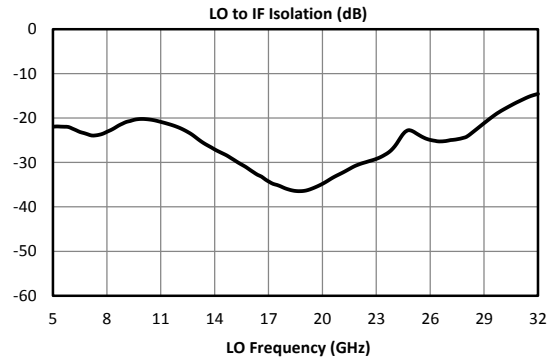
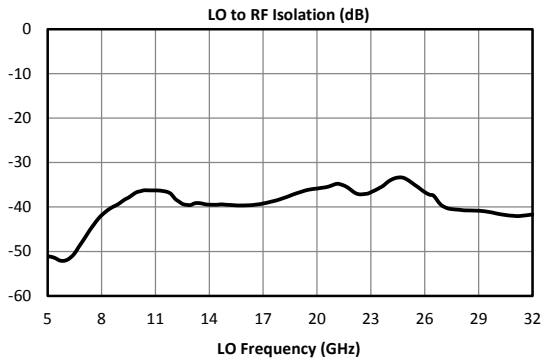
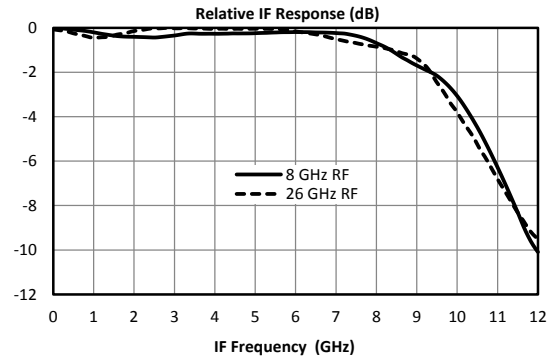
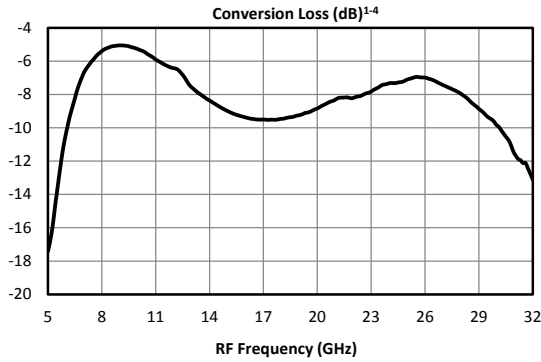

MICROLITHIC™ DOUBLE-BALANCED MIXER

ML1-0626SM

Page 3

LO/Rf 6 to 26 GHz
IF DC to 8 GHz

Typical Performance

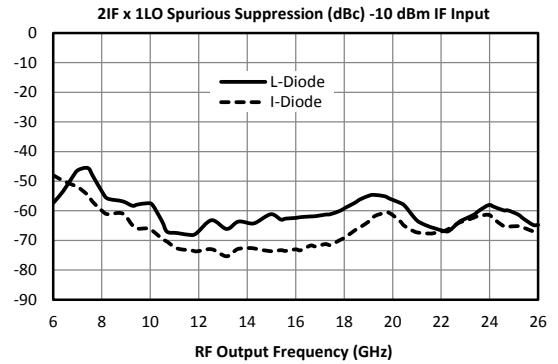
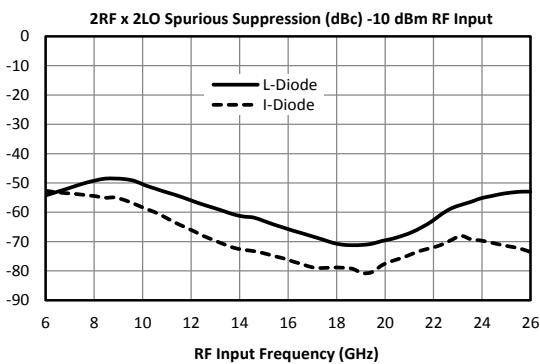
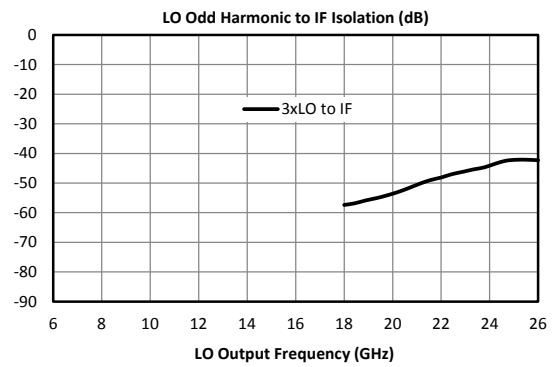
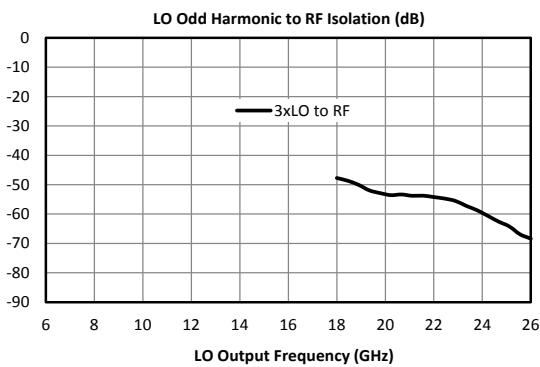
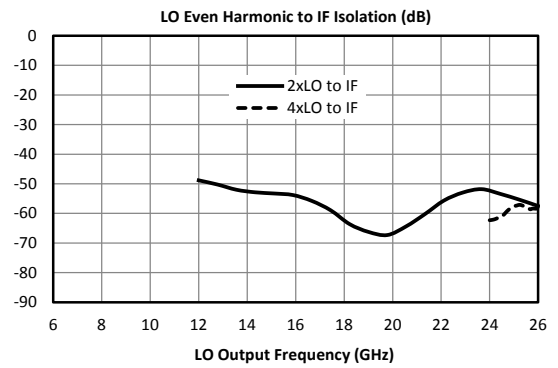
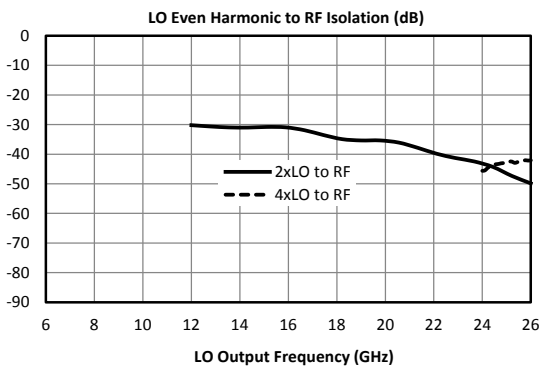
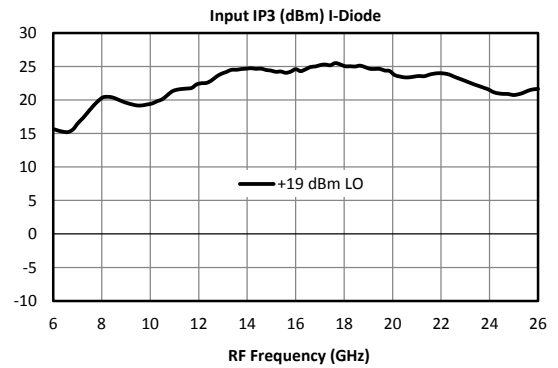
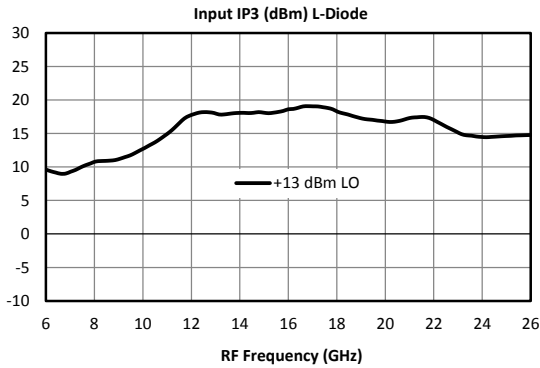

MICROLITHIC™ DOUBLE-BALANCED MIXER

Page 4

ML1-0626SM

LO/RF 6 to 26 GHz
IF DC to 8 GHz

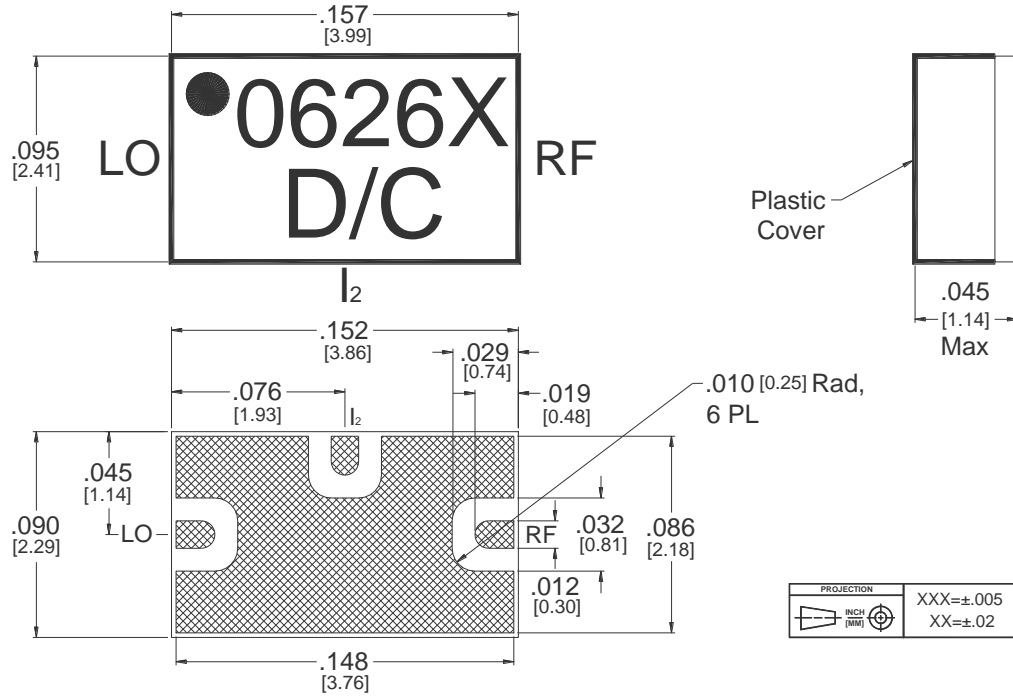

I/O traces and ground plane finish is TiW/NiAu, 0.5 microns Au max over 0.15 microns Ni.

Outline Drawing – SM-2 Package

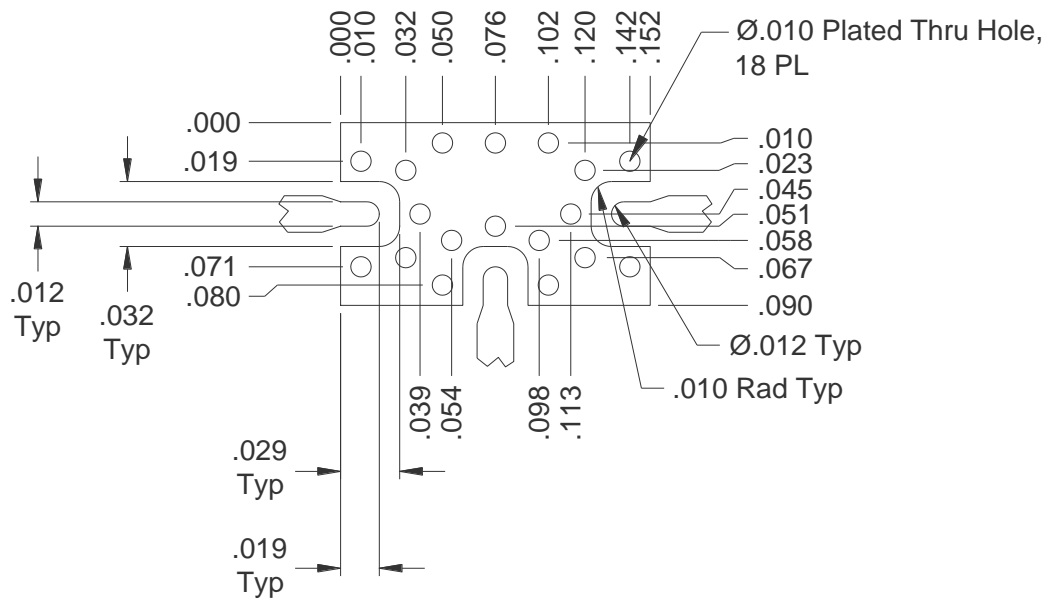

SM-Package Surface-Mount System Circuit Footprint

[Click here for a DXF of the above layout.](#)

[Click here for leaded solder reflow.](#) [Click here for lead-free solder reflow.](#)



MICROLITHIC™ DOUBLE-BALANCED MIXER

ML1-0626SM

Page 5

**LO/RF 6 to 26 GHz
IF DC to 8 GHz**

Downconversion Spurious Suppression

Spurious data is taken by selecting RF and LO frequencies ($\pm mLO \pm nRF$) within the 9 to 36 GHz RF/LO bands, which create a 100 MHz IF spurious output. The mixer is swept across the full spurious band and the mean is calculated. The numbers shown in the table below are for a -10 dBm RF input. Spurious suppression is scaled for different RF power levels by (n-1), where “n” is the RF spur order. For example, the 2RFx2LO spur is 69 dBc for the I-diode version for a -10 dBm input, so a -20 dBm RF input creates a spur that is (2-1) x (-10 dB) dB lower, or 79 dBc.

Typical Downconversion Spurious Suppression (dBc): I-diode (L-diode)⁵

-10 dBm RF Input	0xLO	1xLO	2xLO	3xLO	4xLO	5xLO
1xRF	20 (20)	Reference	22 (24)	11 (12)	33 (32)	17 (18)
2xRF	69 (64)	57 (54)	69 (59)	55 (52)	58 (64)	55 (54)
3xRF	97 (87)	61 (48)	85 (72)	72 (62)	77 (70)	66 (59)
4xRF	119 (111)	108 (96)	106 (92)	114 (104)	113 (102)	106 (98)
5xRF	124 (123)	121 (110)	117 (95)	122 (101)	123 (113)	124 (107)

Upconversion Spurious Suppression

Spurious data is taken by mixing a 100 MHz IF with LO frequencies ($\pm mLO \pm nIF$), which creates an RF within the 9 to 36 GHz RF band. The mixer is swept across the full spurious output band and the mean is calculated. The numbers shown in the table below are for a -10 dBm IF input. Spurious suppression is scaled for different IF input power levels by (n-1), where “n” is the IF spur order. For example, the 2IFx1LO spur is typically 66 dBc for the I-diode version for a -10 dBm input, so a -20 dBm IF input creates a spur that is (2-1) x (-10 dB) dB lower, or 76 dBc.

Typical Upconversion Spurious Suppression (dBc): I-diode (L-diode)⁵

-10 dBm IF Input	0xLO	1xLO	2xLO	3xLO	4xLO	5xLO
1xIF	16 (14)	Reference	20 (21)	10 (11)	31 (32)	20 (27)
2xIF	51 (49)	66 (60)	44 (42)	54 (48)	50 (46)	48 (52)
3xIF	69 (60)	69 (61)	70 (60)	70 (60)	76 (70)	62 (50)
4xIF	108 (101)	112 (102)	92 (81)	116 (104)	106 (91)	100 (90)
5xIF	127 (120)	113 (98)	113 (94)	128 (102)	128 (113)	116 (96)



MICROLITHIC™ DOUBLE-BALANCED MIXER

Page 6

ML1-0626SM

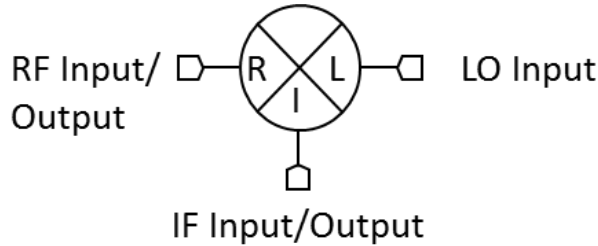
LO/RF 6 to 26 GHz
IF DC to 8 GHz

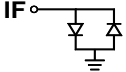

Port	Description	DC Interface Schematic
LO	The LO port is DC short to ground and AC matched to 50 Ohms from 6 to 26 GHz. Blocking capacitor is optional.	
RF	The RF port is DC short to ground and AC matched to 50 Ohms from 6 to 26 GHz. Blocking capacitor is optional.	
IF	The IF port is DC coupled to the diodes. Blocking capacitor is optional.	

Absolute Maximum Ratings	
Parameter	Maximum Rating
RF DC Current	1 Amp
LO DC Current	1 Amp
IF DC Current	50 mA
RF Power Handling (RF+LO)	+25 dBm at +25°C, derated linearly to +20 dBm at +100°C
Operating Temperature	-55°C to +100°C
Storage Temperature	-65°C to +125°C

DATA SHEET NOTES:

- Mixer Conversion Loss Plot IF frequency is 100 MHz.
- Mixer Noise Figure typically measures within 0.5 dB of conversion loss for IF frequencies greater than 5 MHz.
- Conversion Loss typically degrades less than 0.5 dB for LO drives 2 dB below the lowest and 3 dB above highest nominal LO drive levels.
- Conversion Loss typically degrades less than 0.5 dB at +100°C and improves less than 0.5 dB at -55°C.
- Unless otherwise specified L diode data taken with 10 dBm LO drive, I diode data taken with 17 dBm LO drive.
- Specifications are subject to change without notice. Contact Marki Microwave for the most recent specifications and data sheets.
- Catalog mixer circuits are continually improved. Configuration control requires custom mixer model numbers and specifications.

Marki Microwave reserves the right to make changes to the product(s) or information contained herein without notice. Marki Microwave makes no warranty, representation, or guarantee regarding the suitability of its products for any particular purpose, nor does Marki Microwave assume any liability whatsoever arising out of the use or application of any product.

© Marki Microwave, Inc.

