



Product Description

The GRF2501 is an ultra-low noise amplifier (LNA) designed for IEEE 802.11a/n/ac/p applications (5.1 GHz to 5.925 GHz). Over this band, the device exhibits outstanding de-embedded noise figure (NF) of 0.80 dB along with excellent gain flatness and high linearity. The high gain, superior NF and directivity of its design allows designers to create receiver architectures with outstanding cascaded NF and unconditional stability.

The LNA is operated from a single positive supply of 2.7 to 5.0 V with a typical bias condition of 3.3 V and 12 mA. GRF2501 is internally matched to 50 Ω at the input and output ports.

Consult with the GRF applications engineering team for custom tuning/evaluation board data and device s-parameters.

Features

- 4.9 GHz to 6 GHz Operation
- Measurement Reference: 3.3V and 12 mA at 5.5 GHz
- 0.80 dB Noise Figure (De-embedded)
- 16.9 dB Gain
- 2.7 V to 5.0 V Single Supply
- Internally Matched to 50 Ω
- Process: GaAs pHEMT

Applications

- WiFi Access Points
- Mobile WiFi Devices
- Microwave Backhaul
- 802.11p Vehicle Communications

Functional Block Diagram

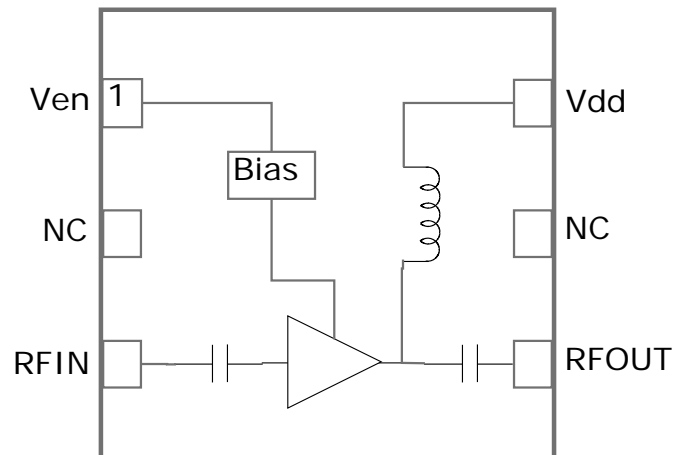

Absolute Ratings:

Parameter	Symbol	Min.	Max.	Unit
Supply Voltage	V _{DD}	0	6.0	V
DC Voltage at Control Port (Pin 1)	V _{ENABLE}	0	5.0	V
RF CW Power into LNA Input	P _{IN MAX}		+15	dBm
Operating Temperature (package heat sink)	T _{AMB}	-40	+105	°C
Maximum Channel Temperature	T _{MAX}		+170	°C
Maximum Dissipated Power	P _{DISS MAX}		200	mW
Electro Static Discharge:				
Charged Device Model: (TBD)	CDM	500		V
Human Body Model: (TBD)	HBM	250		V
Storage:				
Storage Temperature	T _{STG}	-40	+150	°C
Moisture Sensitivity Level	MSL		2	--

Caution! ESD Sensitive Device



Exceeding Absolute Maximum Rating conditions may cause permanent damage to the device.

Pin Out (Top View)

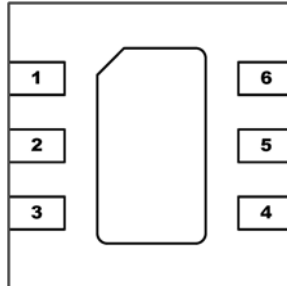

Pin Assignments:

Pin	Name	Description	Note
1	V _{ENABLE}	LNA Enable Input	Venable and series resistor M1 set the device Iddq
2	NC	No Connect or Ground	No internal connection to die
3	RF_In	LNA RF input	Internally matched to 50 Ω. These ports may be DC connected to ground externally but no DC > 0.2 volts should be applied to these ports.
4	RF_Out	LNA RF output	
5	NC	No Connect or Ground	No internal connection to die
6	V _{DD}	Supply Voltage for the LNA	Requires bypass capacitance as close as possible to pin on PCB
PKG BASE	GND	Ground	Provides DC and RF ground for LNA, as well as thermal heat sink. Please see evaluation board assembly diagram for reference.

V_{ENABLE} Truth Table

V _{ENABLE}	Mode
≥1.8 V	LNA On
<0.5 V	LNA Off

Nominal Operating Parameters:

Parameter	Symbol	Specification			Unit	Condition
		Min.	Typ.	Max.		
High Gain Mode						$V_{DD} = 3.3\text{ V}$, $V_{ENABLE} = 3.3\text{ V}$, $T_A = 25^\circ\text{C}$
Test Frequency	f_{TEST}		5500		MHz	
Gain	S21	15.5	16.9		dB	
Gain Flatness	ΔS_{21}		+/- 0.5		dB	Across 5.1 to 5.825 GHz
Input Return Loss	S11		-9.6		dB	
Output Return Loss	S22		-14.4		dB	
Noise Figure	NF		0.80	1.0	dB	(Board Losses De-embedded)
Input Power at 1% EVM	EVM	-21	-19.0		dBm	802.11a modulation
Input 1dB Compression	IP1dB	-10	-8.0		dBm	
Supply Current (Quiescent)	I_{DD}		12		mA	
Enable Current	I_{ENABLE}		1.2		mA	
Disabled Mode						$V_{DD} = 3.3\text{ V}$, $V_{ENABLE} = 0.0\text{V}$
Supply Current (Leakage)	I_{DD}		250		μA	
Enable Current	I_{ENABLE}		0.01		μA	
Thermal Data						
Thermal Resistance (Infra-Red Scan)	Θ_{jc}		141		$^\circ\text{C}/\text{W}$	
Channel Temperature @ +85 C reference (Package heat sink)	$T_{CHANNEL}$		91		$^\circ\text{C}$	Vdd: 3.3 V; Iddq: 12 mA; No RF; Dissipated Power: 40 mW

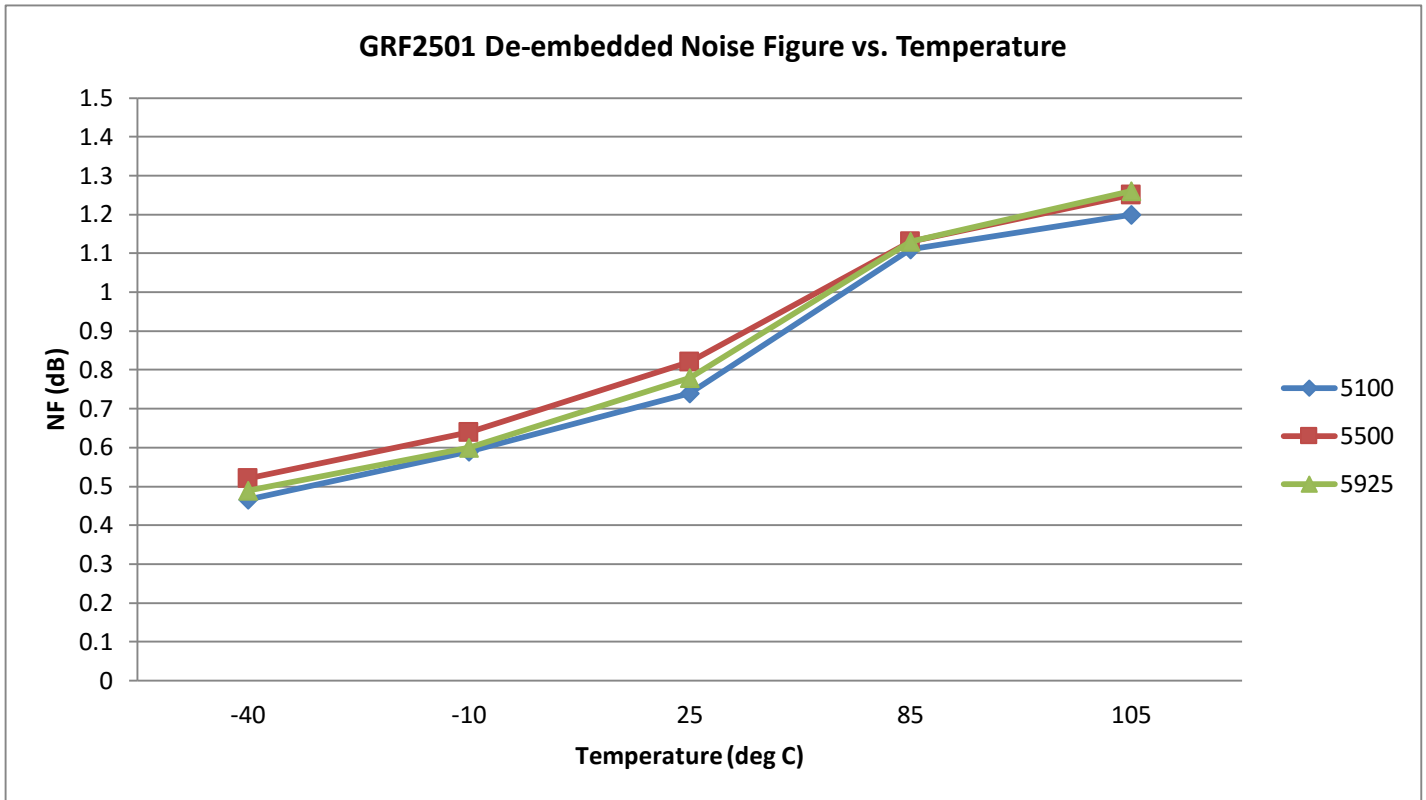
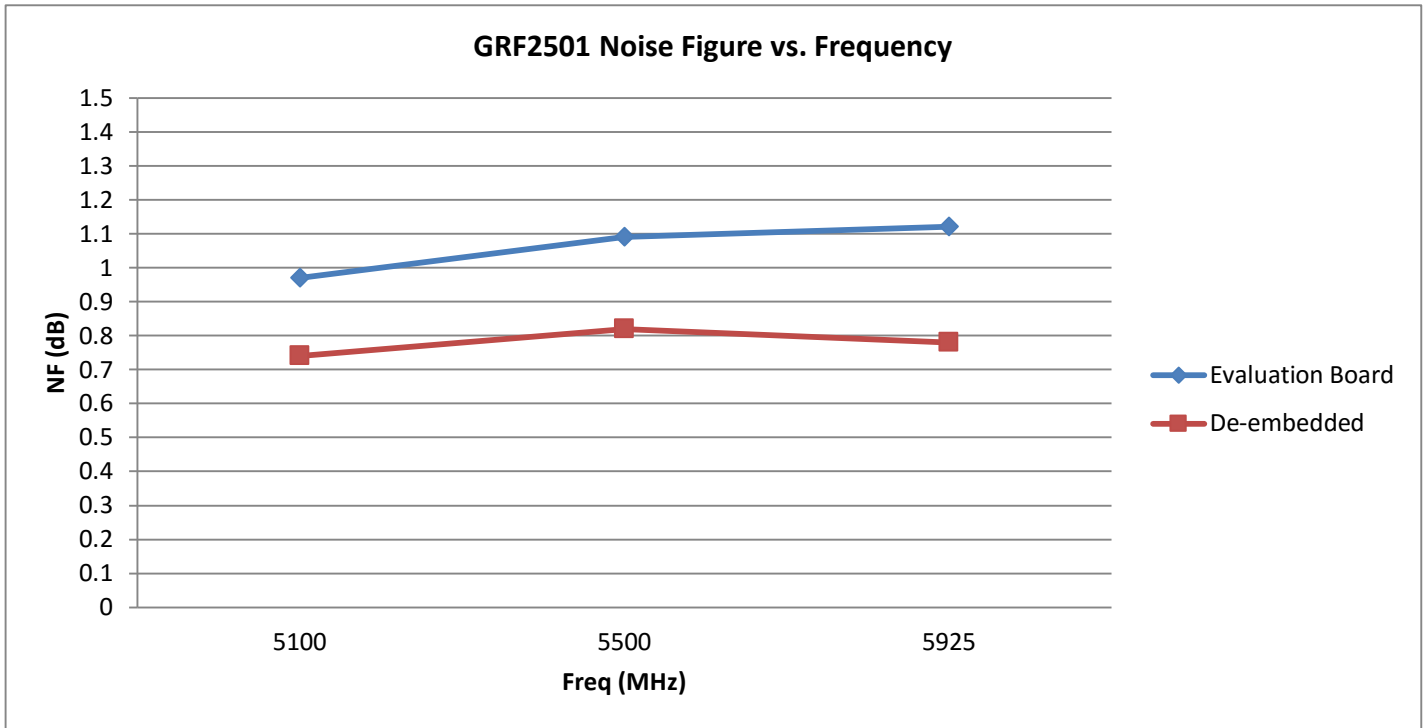

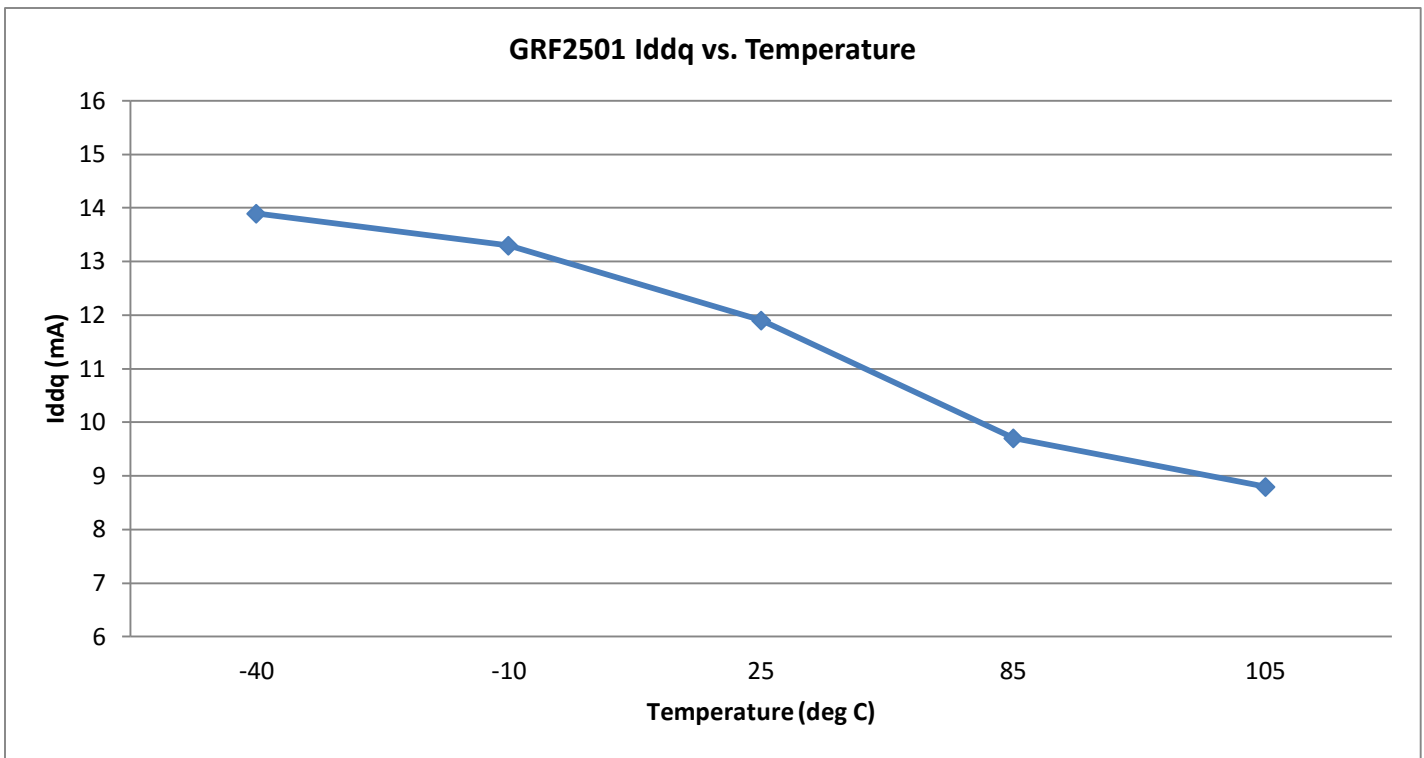
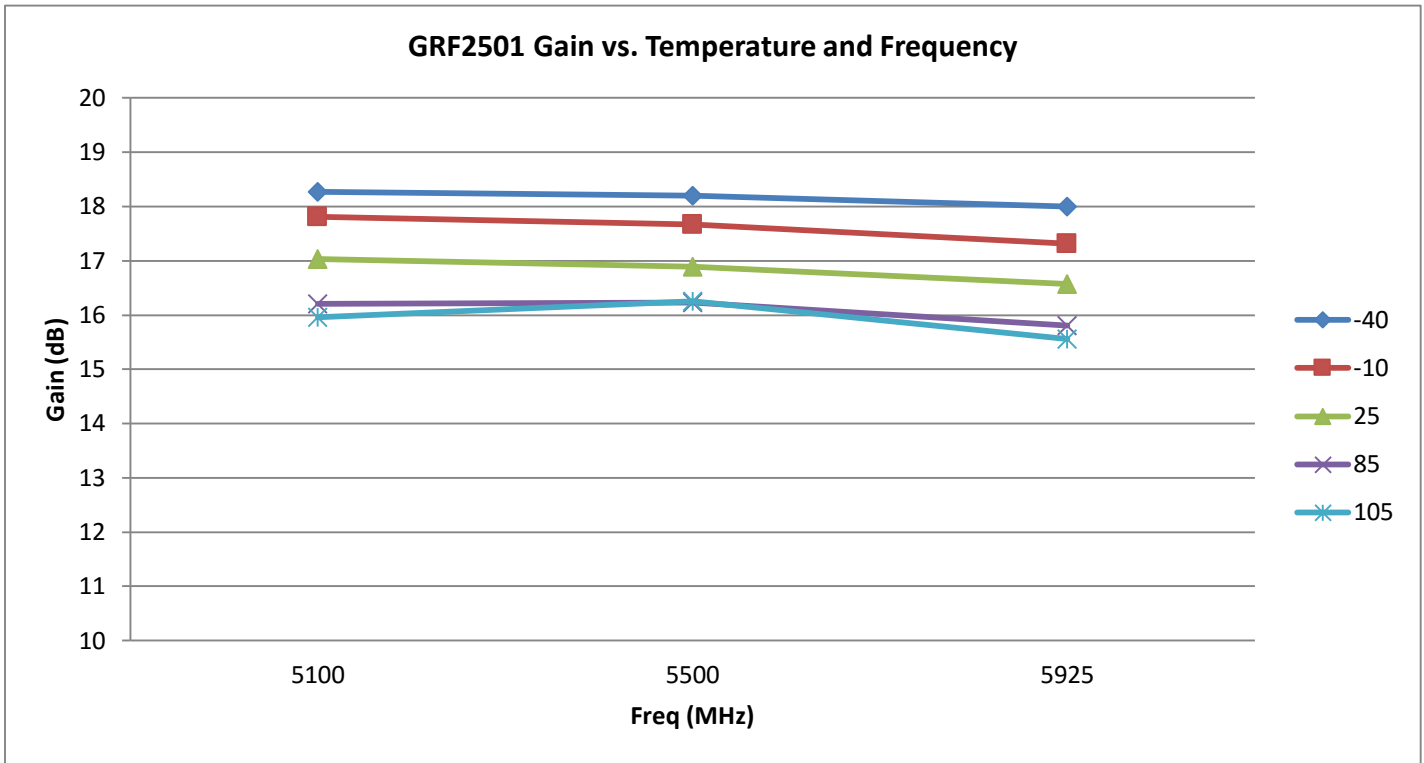

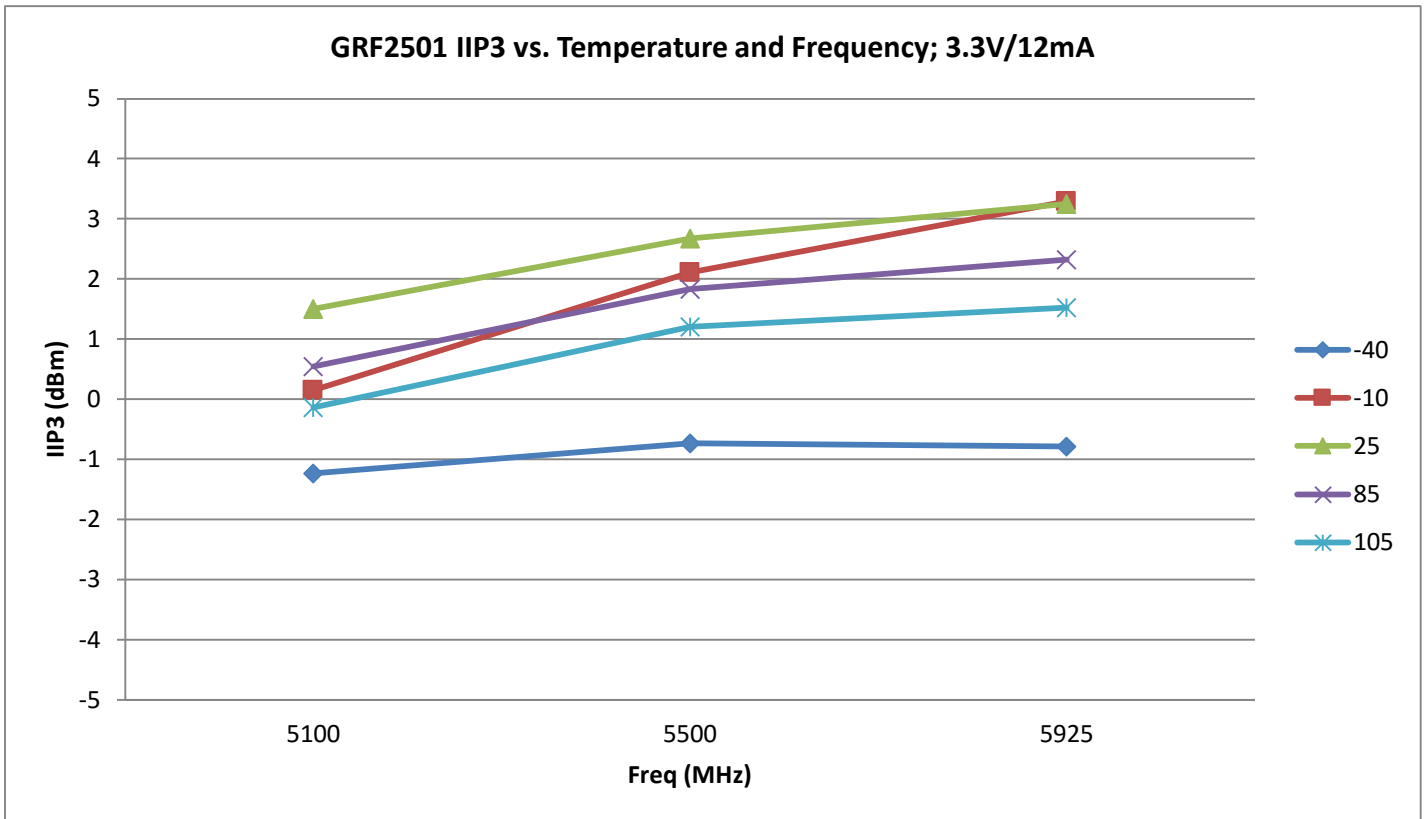
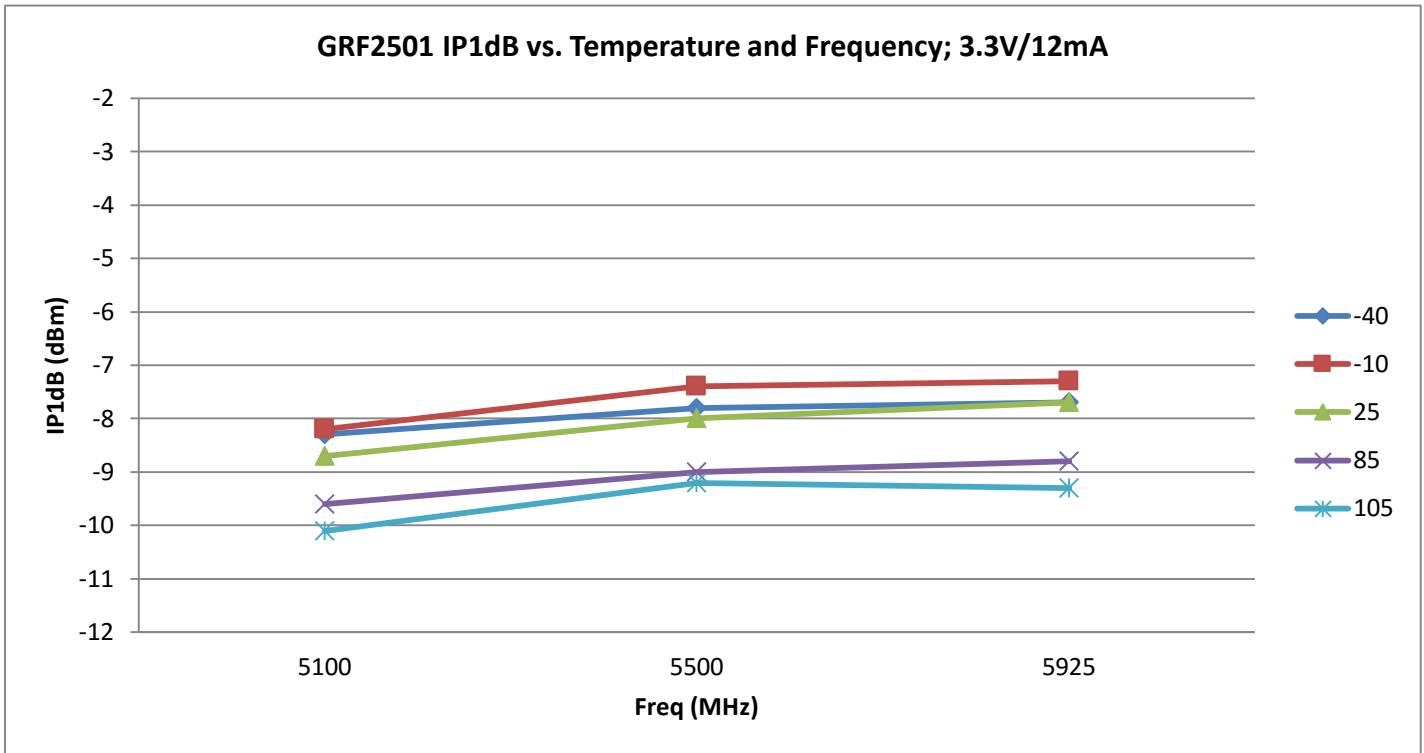

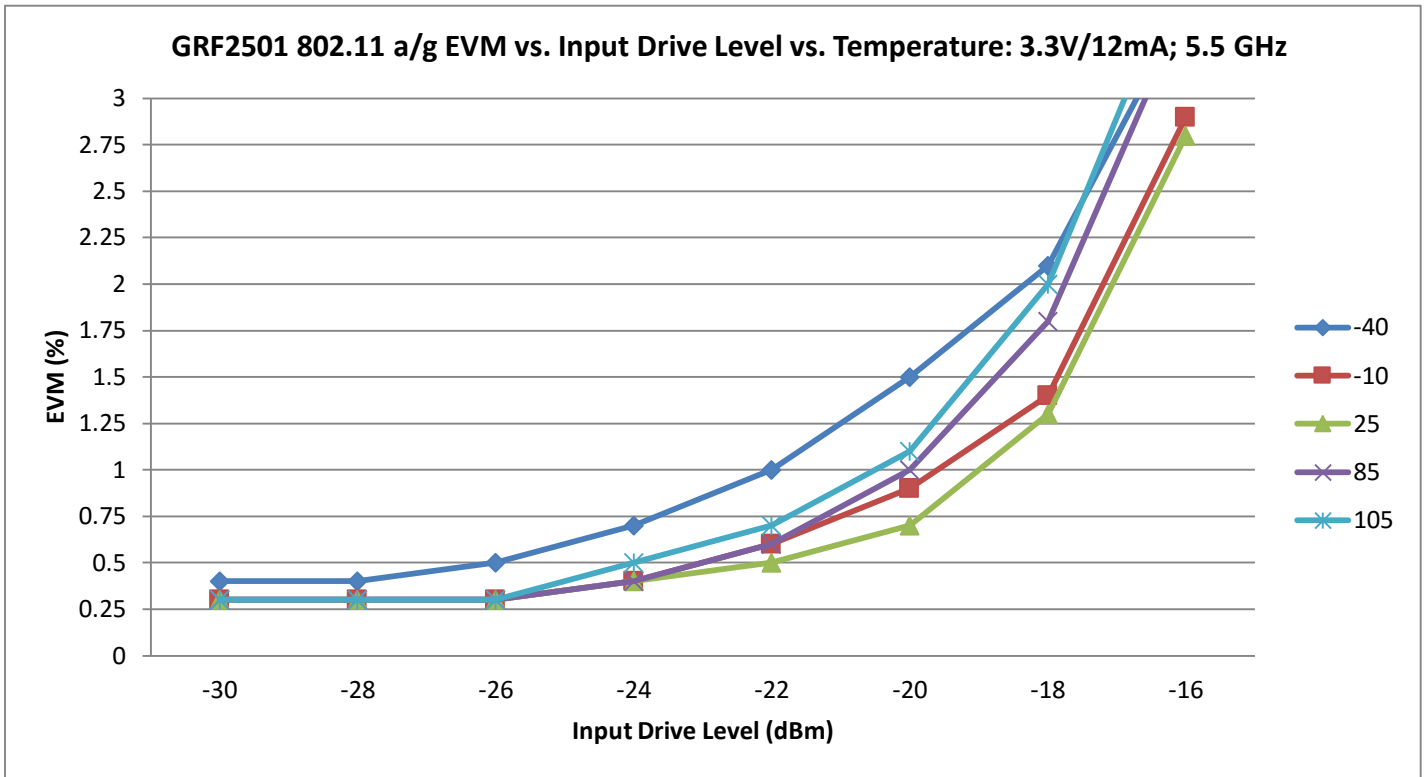
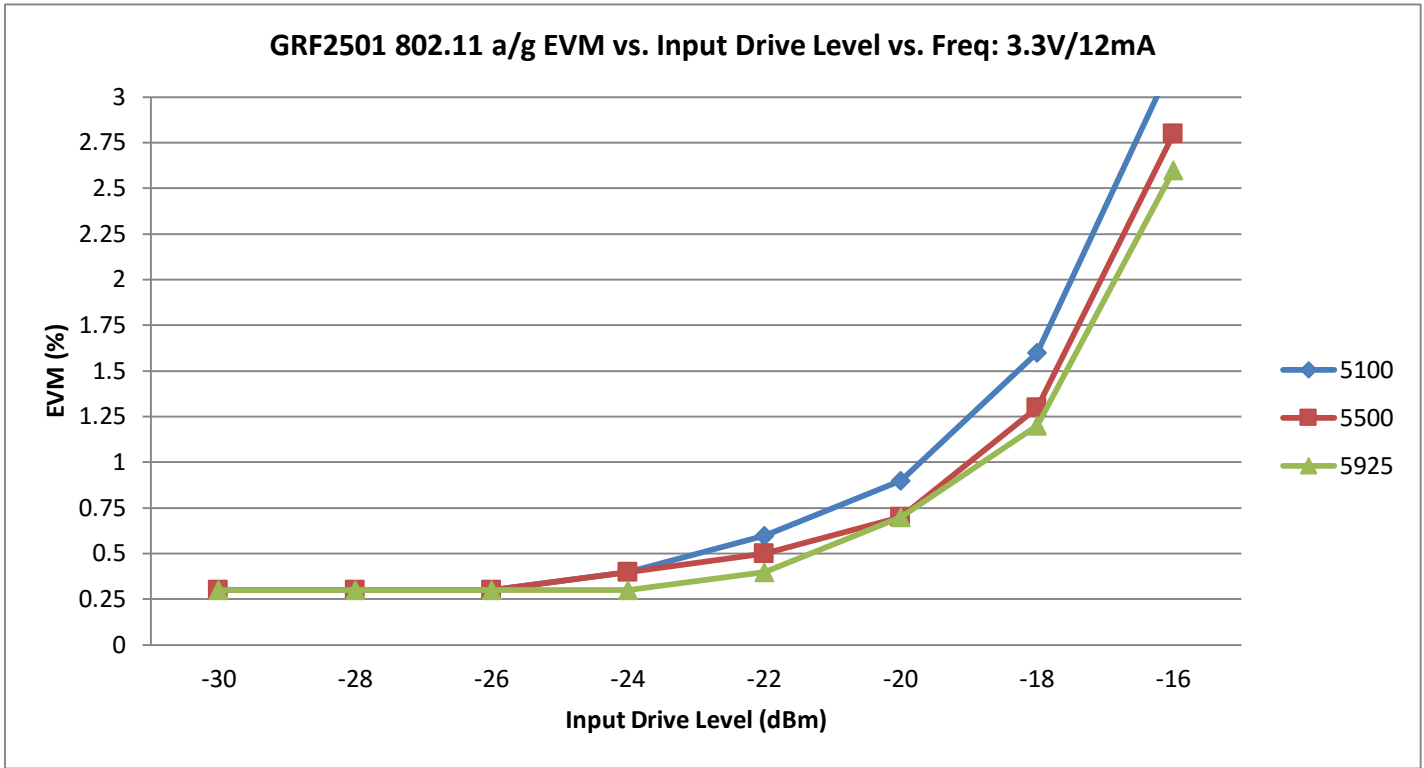

GRF2501 Evaluation Board S-Pars and Stability Mu Factor:

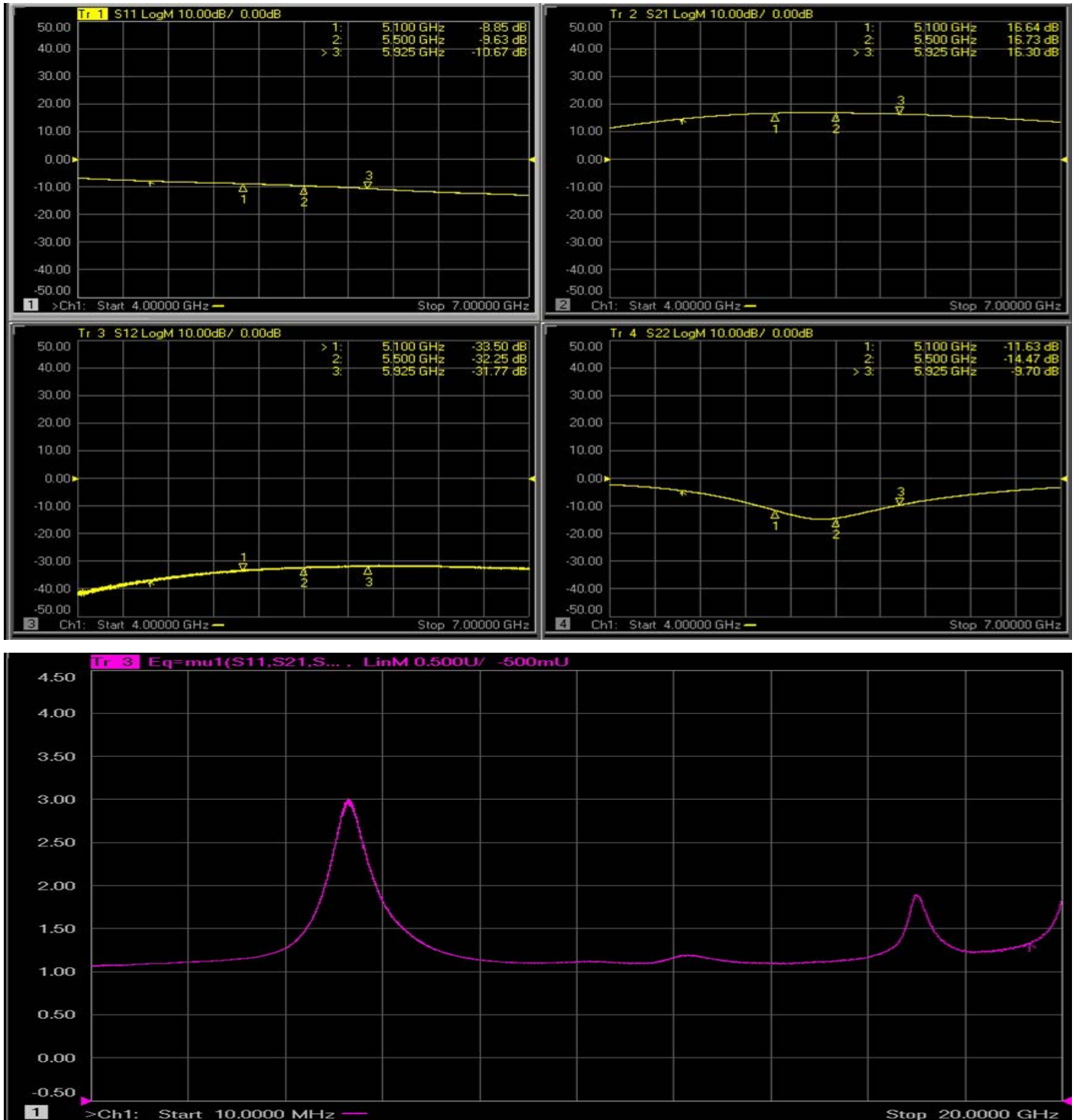

Note: $\mu_1 \geq 1.0$ implies unconditional stability

GRF2501 Theory of Operation:

The device is internally matched with internal DC blocking caps. However, no DC voltage >0.2 volts should be applied externally to the RF input and output ports of the device.

A key element of the application circuit is the low cost ferrite bead in series with the Vdd supply. This ferrite effectively isolates the application circuit so that transmission lines and terminations above it do not affect the device performance. Use of the ferrite also results in improved gain and NF and its use is strongly recommended.

The 1.0 pF external cap to ground at pin 6 should be placed as close as practical to the device for optimal performance. Likewise, the series ferrite bead should be placed close to the 1.0 pF cap to ground so that a compact layout can be achieved.

I_{ddq} is set by the Venable voltage and the external resistor in series with it. For V_{dd} = Venable = 3.3 volts, a resistor value of 1.3k ohms will result in an I_{ddq} of approximately 12 mA.

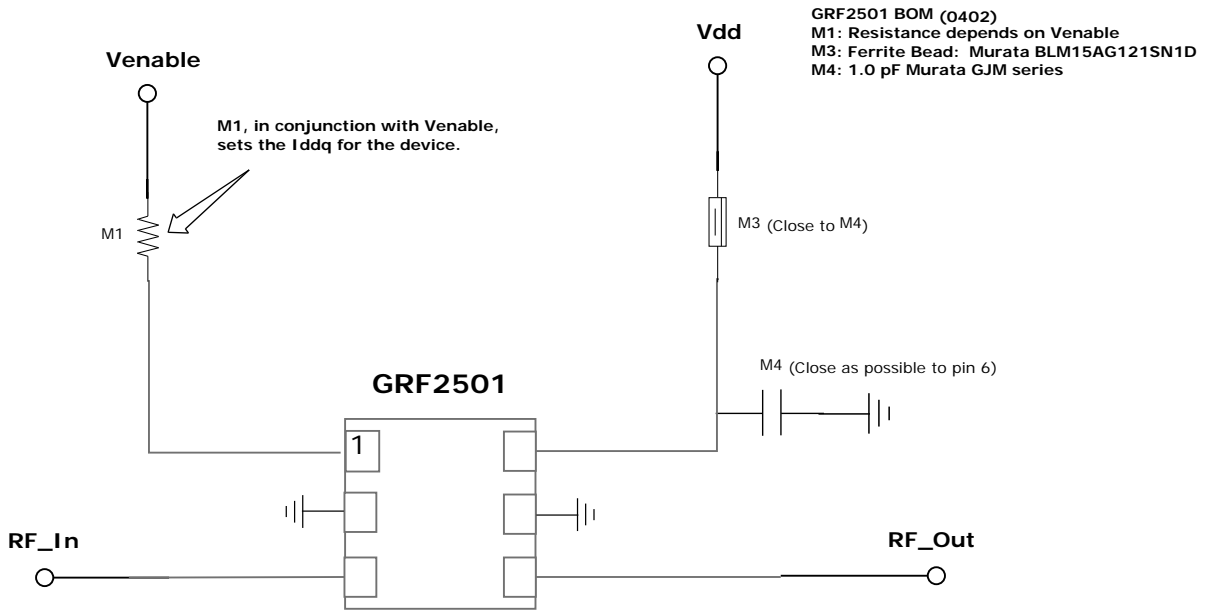

GRF2501 Evaluation Board Application Schematic

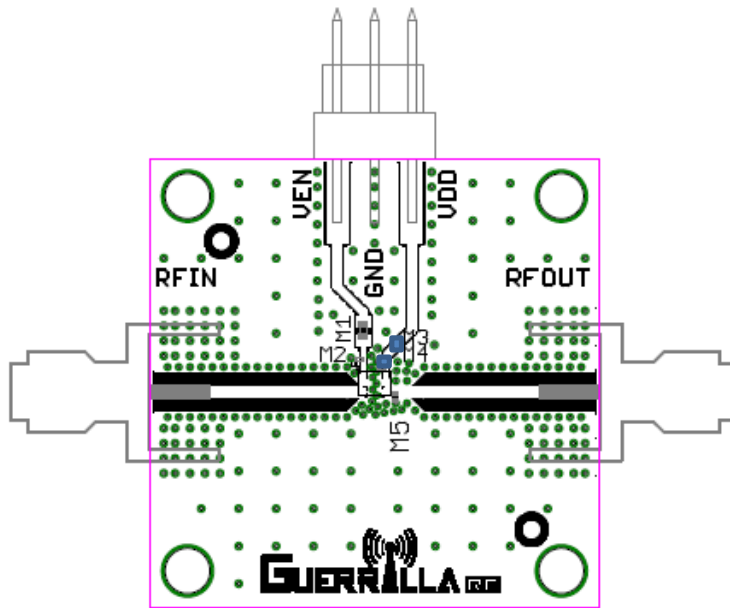

GRF2501 Evaluation Board Assembly Diagram

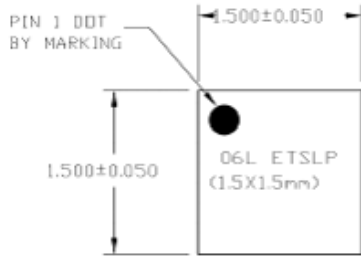

TOP VIEW

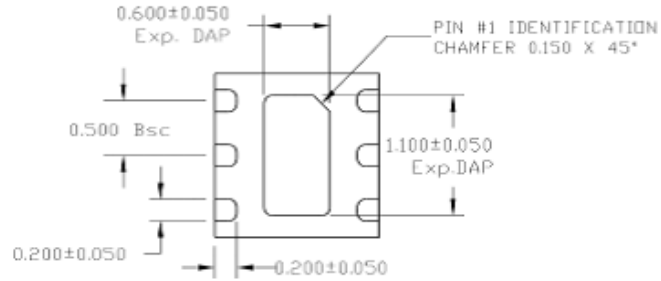

BOTTOM VIEW

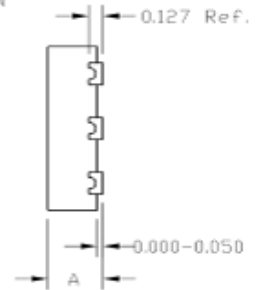

SIDE VIEW

A		ETSLP
	MAX.	0.500
	NOM.	0.450
	MIN.	0.400

				TOLERANCES REFER TO SPECIFICATION ABOVE	UNIT: MM	SCALE: NTS	SYMBOL 	DATE:	
								DATE:	
DESCRIPTION	DATE	BY	APPO					REV.: 00	SHEET NO : 1 OF 1

GRF2501 DFN-6 Package Dimensions

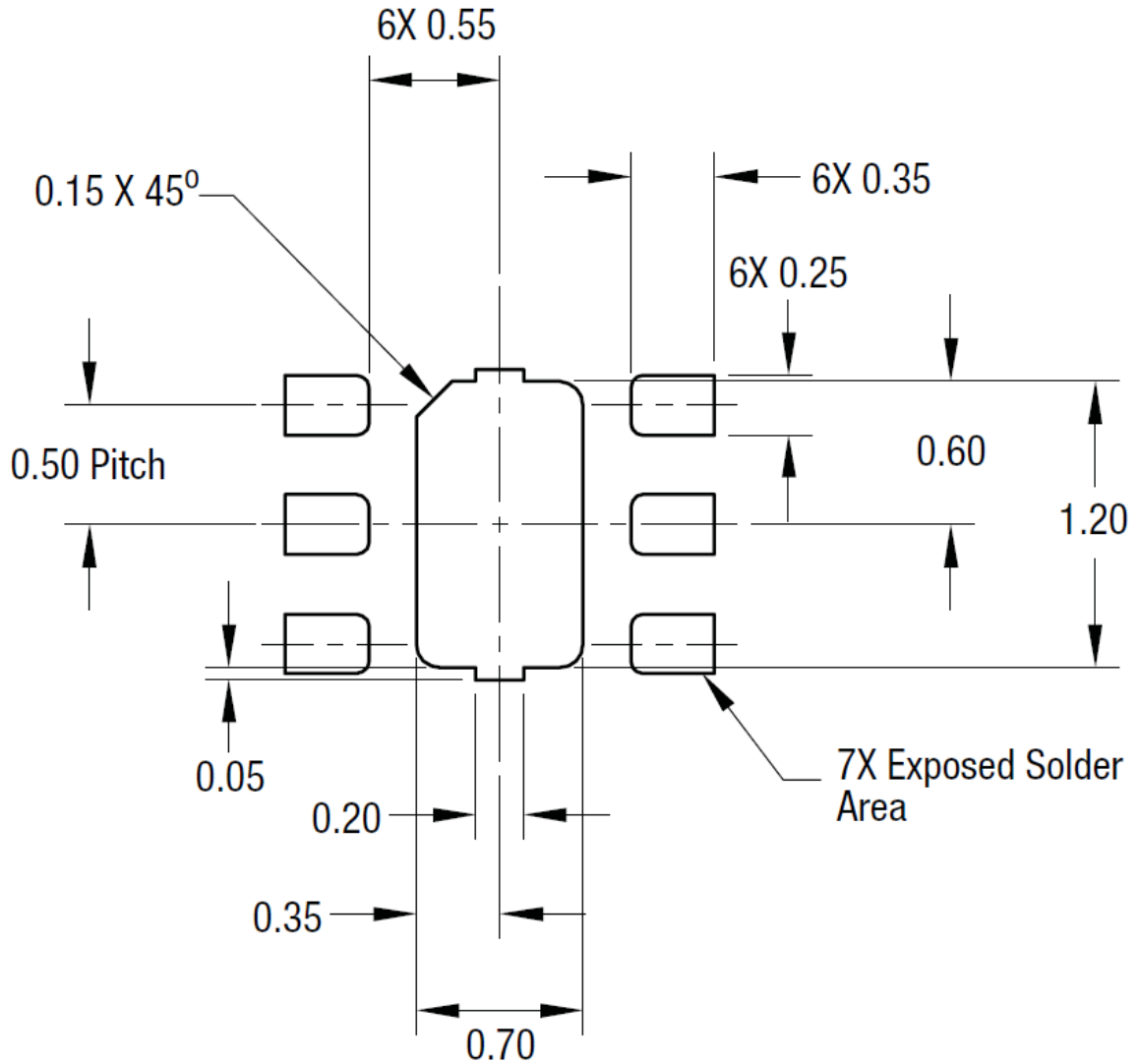

GRF2501 1.5mm x 1.5mm 6-Pin DFN PCB Layout Footprint



Data Sheet Release Status:	Notes
Advance	S-parameter and NF data based on EM simulations for the fully packaged device using foundry supplied transistor s-parameters. Linearity estimates based on device size, bias condition and experience with related devices.
Preliminary	All data based on evaluation board measurements in the Guerrilla RF Applications Lab.
Released	All data based on device qualification data. Typically, this data is nearly identical to the data found in the preliminary version. Max and min values for key RF parameters are included.

Information in this datasheet is specific to the Guerrilla RF, LLC ("Guerrilla RF") product identified.

This datasheet, including the information contained in it, is provided by Guerrilla RF as a service to its customers and may be used for informational purposes only by the customer. Guerrilla RF assumes no responsibility for errors or omissions on this datasheet or the information contained herein. Information provided is believed to be accurate and reliable, however, no responsibility is assumed by Guerrilla RF for its use, nor for any infringement of patents, or other rights of third parties, resulting from its use. Guerrilla RF assumes no liability for any datasheet, datasheet information, materials, products, product information, or other information provided hereunder, including the sale, distribution, reproduction or use of Guerrilla RF products, information or materials.

No license, whether express, implied, by estoppel, by implication or otherwise is granted by this datasheet for any intellectual property of Guerrilla RF, or any third party, including without limitation, patents, patent rights, copyrights, trademarks and trade secrets. All rights are reserved by Guerrilla RF.

All information herein, products, product information, datasheets, and datasheet information are subject to change and availability without notice. Guerrilla RF reserves the right to change component circuitry, recommended application circuitry and specifications at any time without prior notice. Guerrilla RF may further change its datasheet, product information, documentation, products, services, specifications or product descriptions at any time, without notice. Guerrilla RF makes no commitment to update any materials or information and shall have no responsibility whatsoever for conflicts, incompatibilities, or other difficulties arising from any future changes.

GUERRILLA RF INFORMATION, PRODUCTS, PRODUCT INFORMATION, DATASHEETS AND DATASHEET INFORMATION ARE PROVIDED "AS IS" AND WITHOUT WARRANTY OF ANY KIND, WHETHER EXPRESS, IMPLIED, STATUTORY, OR OTHERWISE, INCLUDING FITNESS FOR A PARTICULAR PURPOSE OR USE, MERCHANTABILITY, PERFORMANCE, QUALITY OR NON-INFRINGEMENT OF ANY INTELLECTUAL PROPERTY RIGHT; ALL SUCH WARRANTIES ARE HEREBY EXPRESSLY DISCLAIMED. GUERRILLA RF DOES NOT WARRANT THE ACCURACY OR COMPLETENESS OF THE INFORMATION, TEXT, GRAPHICS OR OTHER ITEMS CONTAINED WITHIN THESE MATERIALS. GUERRILLA RF SHALL NOT BE LIABLE FOR ANY DAMAGES, INCLUDING BUT NOT LIMITED TO ANY SPECIAL, INDIRECT, INCIDENTAL, STATUTORY, OR CONSEQUENTIAL DAMAGES, INCLUDING WITHOUT LIMITATION, LOST REVENUES OR LOST PROFITS THAT MAY RESULT FROM THE USE OF THE MATERIALS OR INFORMATION, WHETHER OR NOT THE RECIPIENT OF MATERIALS HAS BEEN ADVISED OF THE POSSIBILITY OF SUCH DAMAGE.

Customers are solely responsible for their use of Guerrilla RF products in the Customer's products and applications or in ways which deviate from Guerrilla RF's published specifications, either intentionally or as a result of design defects, errors, or operation of products outside of published parameters or design specifications. Customers should include design and operating safeguards to minimize these and other risks. Guerrilla RF assumes no liability or responsibility for applications assistance, customer product design, or damage to any equipment resulting from the use of Guerrilla RF products outside of stated published specifications or parameters.