

Features

- ▶ Ultra wideband performance
- ▶ Low noise figure
- ▶ Low current consumption
- ▶ Excellent return losses
- ▶ Pb-free RoHs compliant 4x4 QFN package

Description

The CMD241P4 is wideband GaAs MMIC distributed low noise amplifier housed in a leadless 4x4 mm surface mount package. The amplifier operates from 2 to 22 GHz and delivers greater than 13 dB of gain with a corresponding noise figure of 2.3 dB and an output 1 dB compression point of +21 dBm at 11 GHz. The CMD241P4 is a 50 ohm matched design which eliminates the need for external DC blocks and RF port matching.

Functional Block Diagram

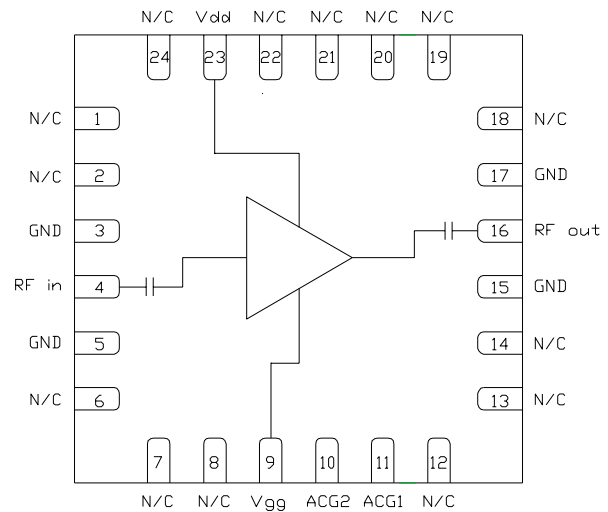

Electrical Performance – $V_{dd} = 5.0\text{ V}$, $I_{dd} = 74\text{ mA}$, $T_A = 25\text{ }^\circ\text{C}$, $F=11\text{ GHz}$

Parameter	Min	Typ	Max	Units
Frequency Range	2 – 22			GHz
Gain		13.5		dB
Noise Figure		2.3		dB
Input Return Loss		18		dB
Output Return Loss		15		dB
Output P1dB		21		dBm
Output IP3		28		dBm
Supply Current		74		mA

Specifications

Absolute Maximum Ratings

Parameter	Rating
Drain Voltage, V _{dd}	10 V
Gate Voltage, V _{gg}	-2.5 to 0 V
RF Input Power	+20 dBm
Channel Temperature, T _{ch}	150 °C
Power Dissipation, P _{diss}	1.75 W
Thermal Resistance, Θ_{JC}	37 °C/W
Operating Temperature	-40 to 85 °C
Storage Temperature	-55 to 150 °C

Operation of this device outside the maximum ratings may cause permanent damage.

Recommended Operating Conditions

Parameter	Min	Typ	Max	Units
V _{dd}	3.0	5.0	8.0	V
I _{dd}		74		mA
V _{gg}		-0.65		V

Electrical performance is measured at specific test conditions. Electrical specifications are not guaranteed over all recommended operating conditions.

Electrical Specifications, V_{dd} = 5.0 V, I_{dd} = 74mA, T_A = 25 °C

Parameter	Min	Typ	Max	Min	Typ	Max	Min	Typ	Max	Units
Frequency Range	2 – 6			6 – 18			18 – 22			GHz
Gain	10	13		10.5	13.5		11	14.5		dB
Noise Figure		3.5			2.5			3.75		dB
Input Return Loss		12			13			15		dB
Output Return Loss		15			15			9		dB
Output P1dB	16	20		14	18		14	17		dBm
Output IP3		29			28			25		dBm
Supply Current	50	74	100	50	74	100	50	74	100	mA
Gain Temperature Coefficient		0.007			0.009			0.016		dB/°C
Noise Figure Temperature Coefficient		0.01			0.009			0.014		dB/°C

ver 1.0 0517

Typical Performance

Broadband Performance, $V_{dd} = 5.0$, $I_{dd} = 74$ mA, $T_A = 25$ °C

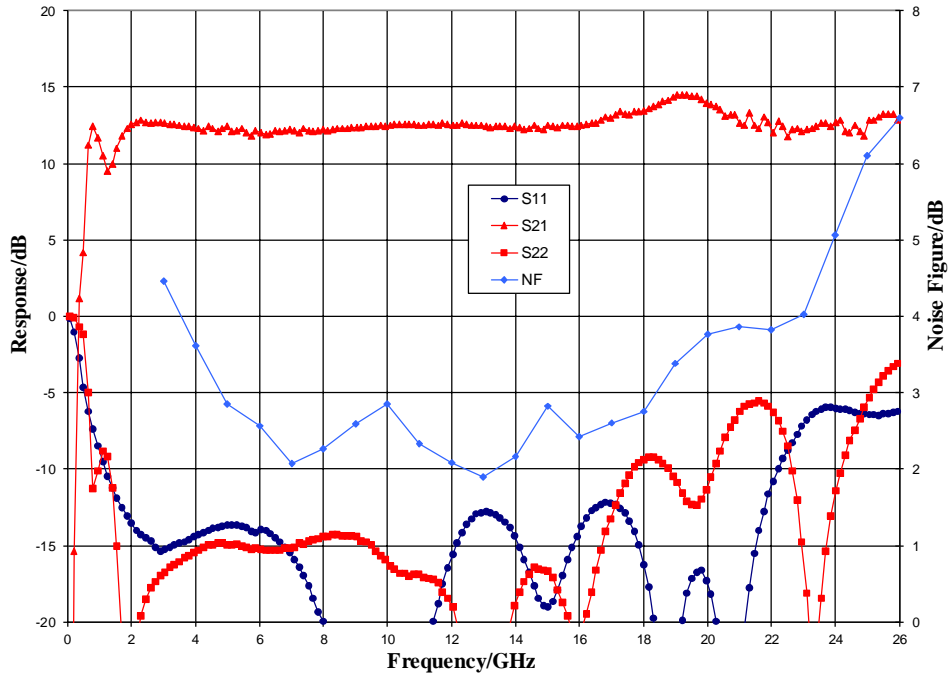

Narrow-band Performance, $V_{dd} = 5.0$ V, $I_{dd} = 74$ mA, $T_A = 25$

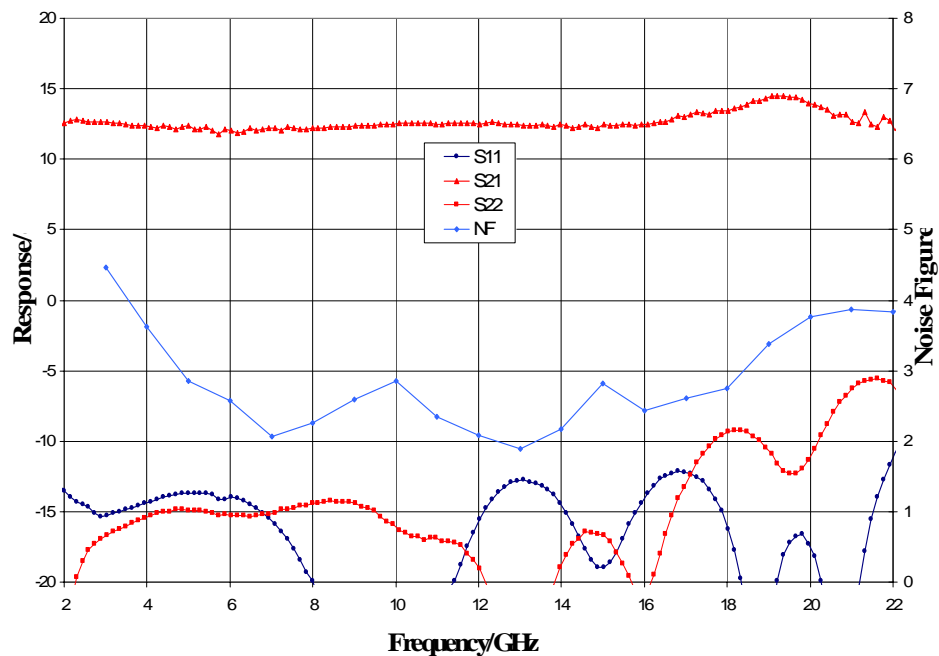

ver 1.0 0517

Typical Performance

Gain vs. Temperature, $V_{dd} = 5.0\text{ V}$, $I_{dd} = 74\text{ mA}$

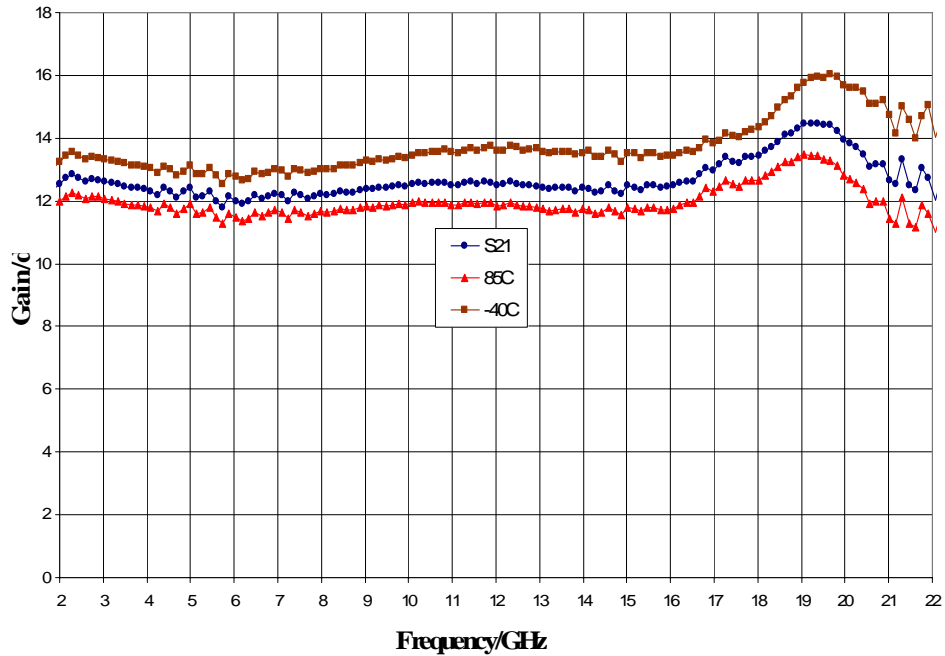

Noise Figure vs. Temperature, $V_{dd} = 5.0\text{ V}$, $I_{dd} = 74\text{ mA}$

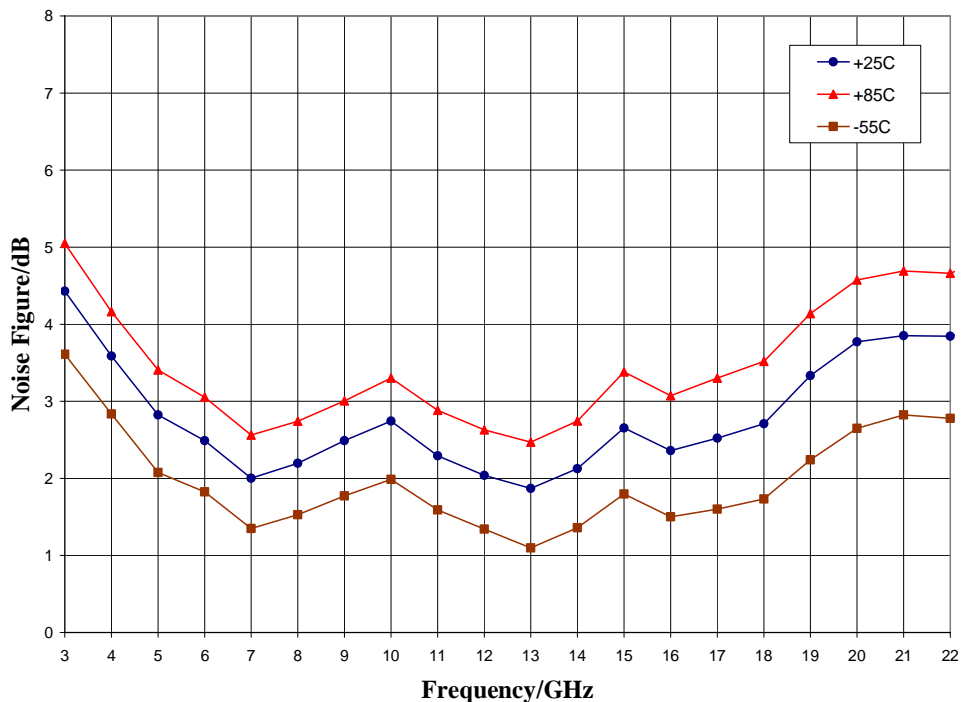

ver 1.0 0517

Typical Performance

Output Power, $V_{dd} = 5.0\text{ V}$, $I_{dd} = 74\text{ mA}$, $T_A = 25\text{ }^\circ\text{C}$

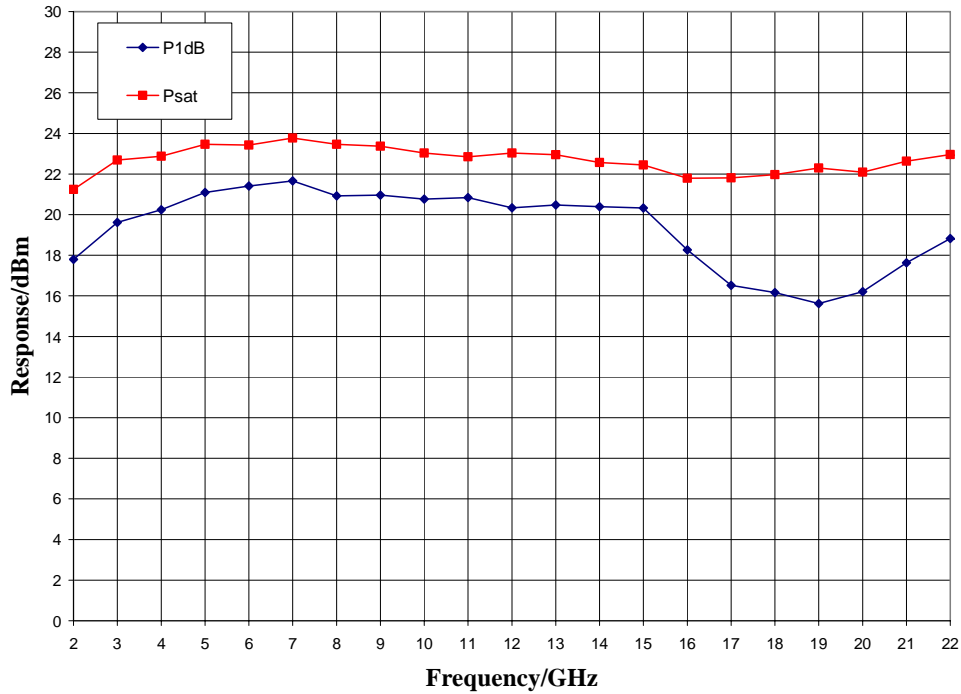

P1dB vs. Temperature, $V_{dd} = 5.0\text{ V}$, $I_{dd} = 74\text{ mA}$

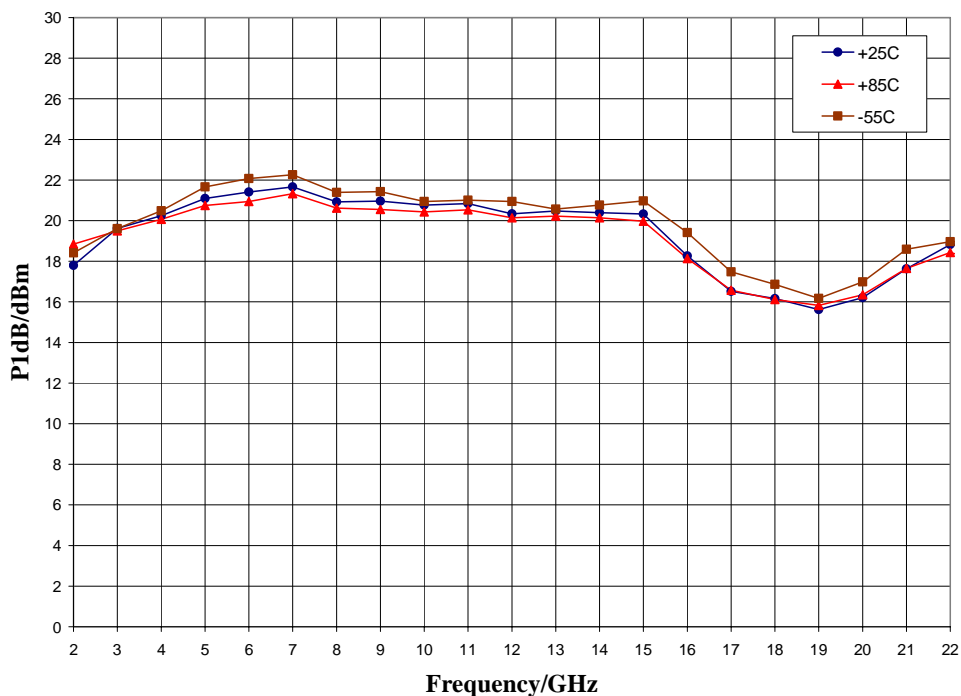

ver 1.0 0517

Typical Performance

Output IP3 vs. Temperature, $V_{dd} = 5.0$ V, $I_{dd} = 74$ mA, $T_A = 25$ °C

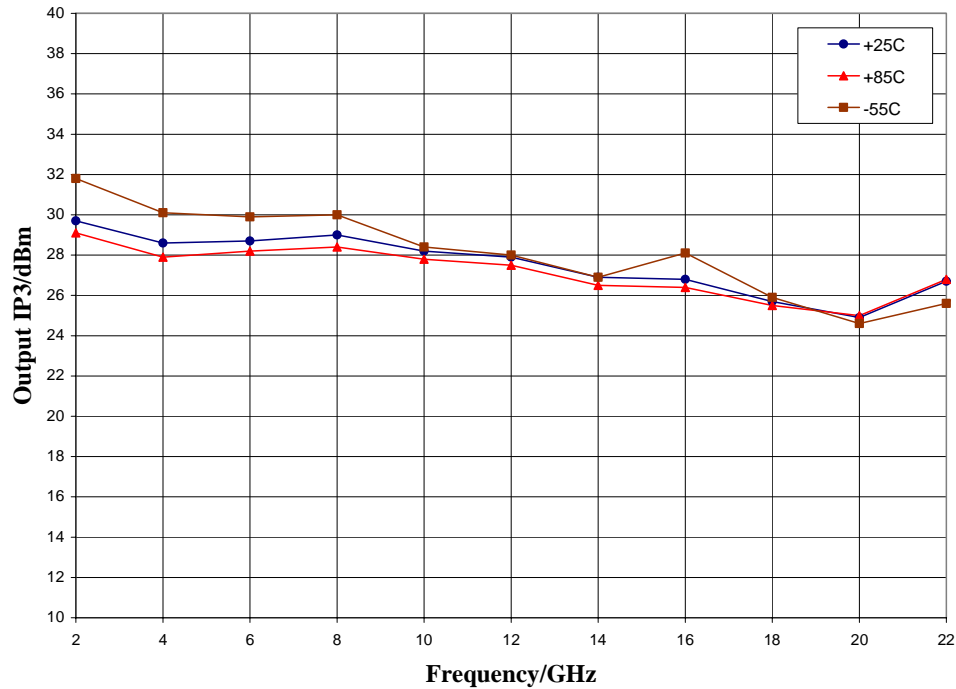

Mechanical Information

Package Information and Dimensions

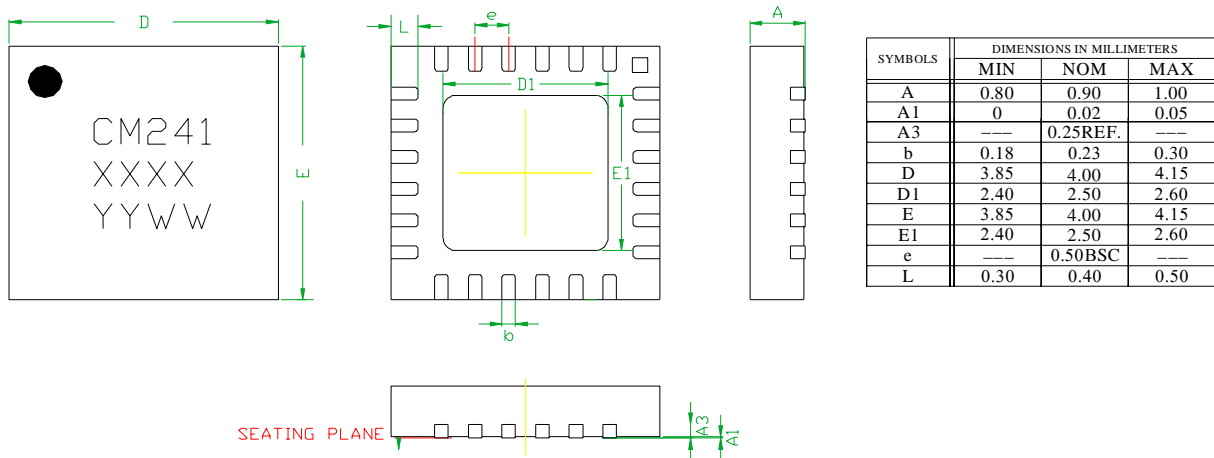

- NOTES:
1. DIMENSIONS ARE IN MILLIMETERS
 2. RoHS COMPLIANT MOLD COMPOUND
 3. LEADFRAME MATERIAL: COPPER ALLOY
 4. LEAD FINISH: 100% MATTE Sn
 5. INDICATED DIMENSION/TOLERANCE APPLIES TO LEADS AND EXPOSED PAD

Recommended PCB Land Pattern

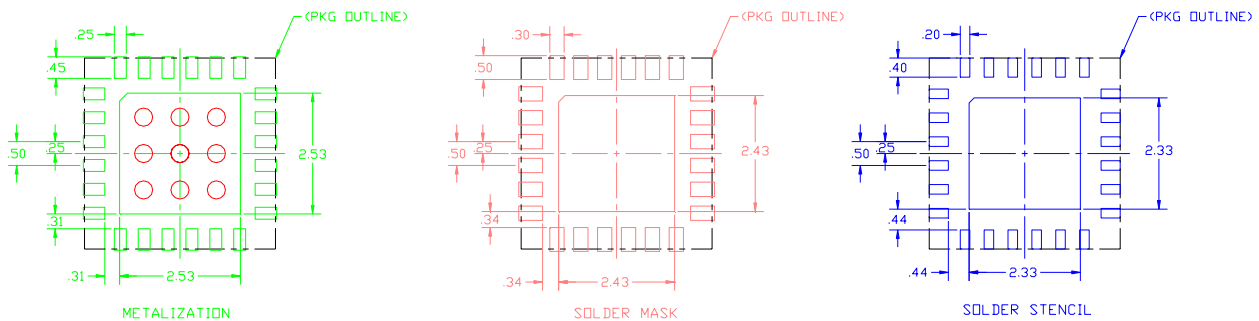



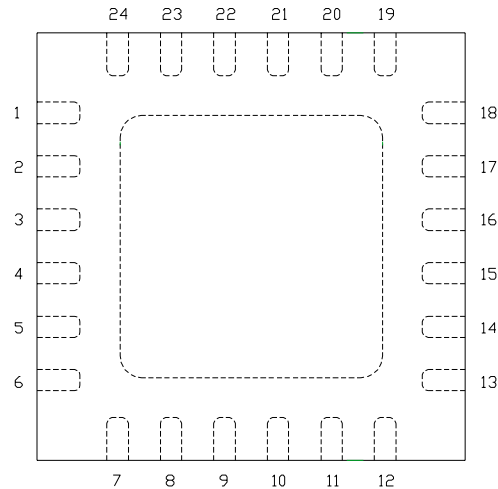

Pin Description

Pin Diagram

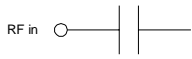
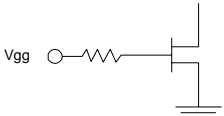
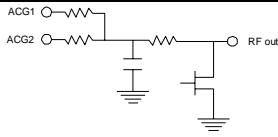

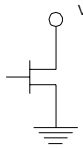
Functional Description

Pad	Function	Description	Schematic
1, 2, 6-8, 12-14, 18-22, 24	N/C	No connection required. These pins may be connected to RF/DC ground	
4	RF in	DC blocked and 50 ohm matched	
9	V _{gg}	Power supply voltage Decoupling and bypass caps required	
10, 11	ACG2, 1	Low Frequency Termination Attach bypass capacitor per application circuit	
16	RF out	DC blocked and 50 ohm matched	
23	V _{dd}	Power supply voltage Decoupling and bypass caps required	
3, 5, 15, 17 and die paddle	Ground	Connect to RF / DC ground	

ver 1.0 0517

Applications Information

Application Circuit

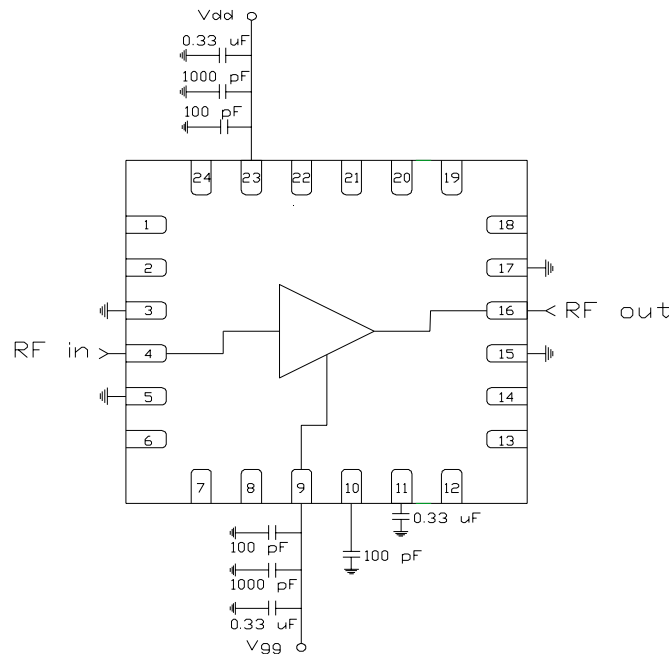

Biasing and Operation

The CMD241P4 is biased with a positive drain supply and a negative gate supply. Performance is optimized when the drain voltage is set to +5.0 V. The nominal gate voltage is -0.65 V.

Turn ON procedure:

1. Apply gate voltage V_{gg} and set to -2 V
2. Apply drain voltage V_{dd} and set to +5 V
3. Increase V_{gg} (less negative) to achieve a drain current of 74 mA

Turn OFF procedure:

1. Turn off drain voltage V_{dd}
2. Turn off gate voltage V_{gg}

RF power can be applied at any time.

GaAs MMIC devices are susceptible to damage from Electrostatic Discharge. Proper precautions should be observed during handling, assembly and test.

ver 1.0 0517

Applications Information

Evaluation Board

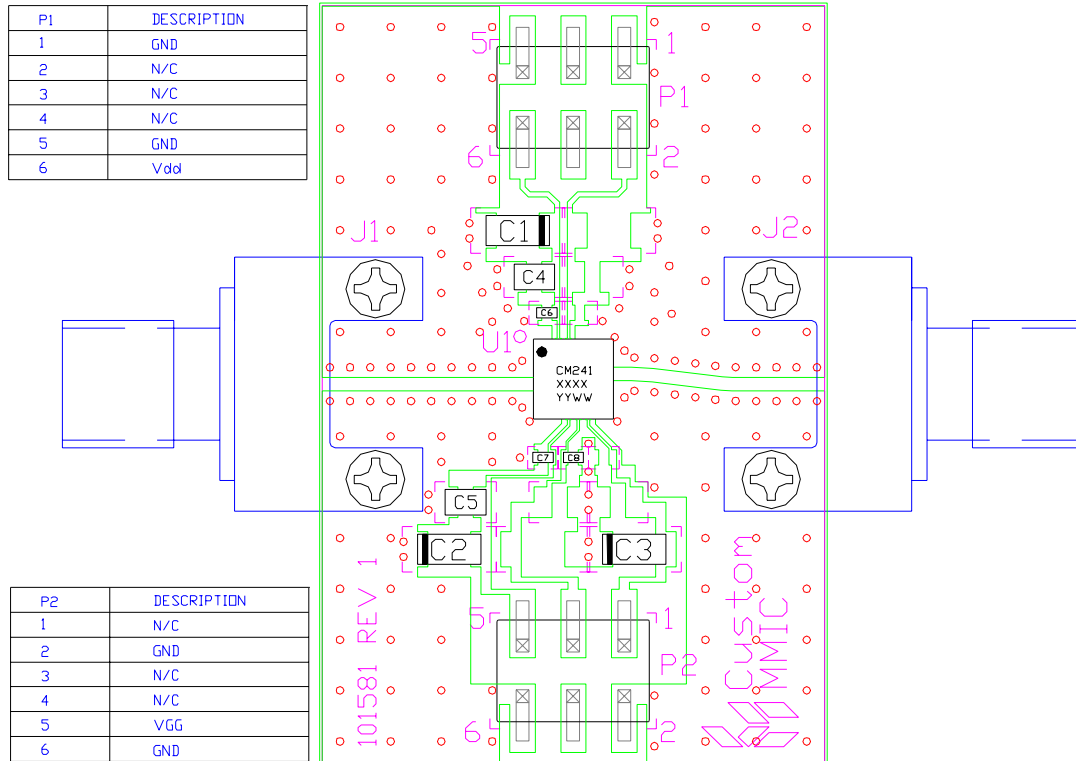

Bill of Material

Designator	Value	Description
J1, J2		SMA END LAUNCH CONNECTOR
P1, P2		6 PIN DC HEADER
C1-C3	0.33 uF	CAPACITOR, TANTALUM
C4	1000 pF	CAPACITOR, 0603,
C8	100 pF	CAPACITOR, 0402
C5-C6	10 pF	CAPACITOR, 0402
C7	22 pF	CAPACITOR, 0402