

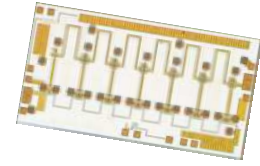

# Let Performance Drive

## CMD192

### DC-20 GHz Distributed Driver Amplifier



#### Features

- ▶ Ultra wideband performance
- ▶ Positive gain slope
- ▶ High output power
- ▶ Low noise figure
- ▶ Small die size

#### Applications

- ▶ Microwave radio and VSAT
- ▶ Telecom infrastructure
- ▶ Test instrumentation
- ▶ Military and space

#### Description

The CMD192 is wideband GaAs MMIC distributed amplifier die which operates from DC to 20 GHz. The amplifier delivers greater than 19 dB of gain with a corresponding output 1 dB compression point of +24.5 dBm and noise figure of 1.9 dB at 10 GHz. The CMD192 is a 50 ohm matched design which eliminates the need for RF port matching. The CMD192 offers full passivation for increased reliability and moisture protection. This amplifier is the perfect alternative to higher cost hybrid amplifiers.

#### Functional Block Diagram

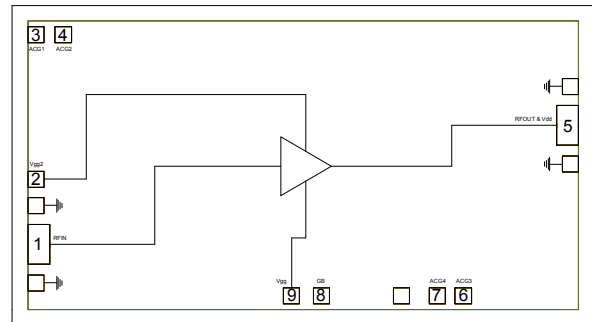

Note: Vgg2 is optional for gain control

#### Electrical Performance - $V_{dd} = 8.0\text{ V}$ , $V_{gg} = -1.0\text{ V}$ , $T_A = 25\text{ }^\circ\text{C}$ , $F=10\text{ GHz}$

Parameter	Min	Typ	Max	Units
Frequency Range	DC - 20			GHz
Gain		19.5		dB
Noise Figure		1.9		dB
Input Return Loss		25		dB
Output Return Loss		15		dB
Output P1dB		24.5		dBm
Supply Current		200		mA

ver 2.1 1214



# CMD192

## DC-20 GHz Distributed Driver Amplifier

### Specifications

#### Absolute Maximum Ratings

Parameter	Rating
Drain Voltage, V <sub>dd</sub>	10 V
Gate Voltage, V <sub>gg</sub>	-4 to 0 V
RF Input Power	+23 dBm
Channel Temperature, T <sub>ch</sub>	150 °C
Power Dissipation, P <sub>diss</sub>	2.8 W
Thermal Resistance	23.2 °C/W
Operating Temperature	-55 to 85 °C
Storage Temperature	-55 to 150 °C

Operation of this device outside the maximum ratings may cause permanent damage.

#### Recommended Operating Conditions

Parameter	Min	Typ	Max	Units
V <sub>dd</sub>	5.0	8.0	10.0	V
I <sub>dd</sub>		200		mA
V <sub>gg</sub>	-4.0	-1.0	0	V

Electrical performance is measured at specific test conditions. Electrical specifications are not guaranteed over all recommended operating conditions.

#### Electrical Specifications, V<sub>dd</sub> = 8.0 V, V<sub>gg</sub> = -1.0 V, T<sub>A</sub> = 25 °C

Parameter	Min	Typ	Max	Min	Typ	Max	Units
Frequency Range	DC - 10			10 - 20			GHz
Gain	15.5	18.5		17	20		dB
Noise Figure		2			2.5		dB
Input Return Loss		20			15		dB
Output Return Loss		20			15		dB
Output P1dB	22	24.5		19	22		dBm
Output IP3		31			29		dBm
Supply Current	140	200	260	140	200	260	mA
Gain Temperature Coefficient		0.012			0.02		dB/°C
Noise Figure Temperature Coefficient		0.006			0.009		dB/°C

ver 2.1 1214

### Typical Performance

**Broadband Performance,  $V_{dd} = 8.0$  V,  $V_{gg} = -1.0$  V,  $I_{dd} = 170$  mA,  $T_A = 25$  °C**

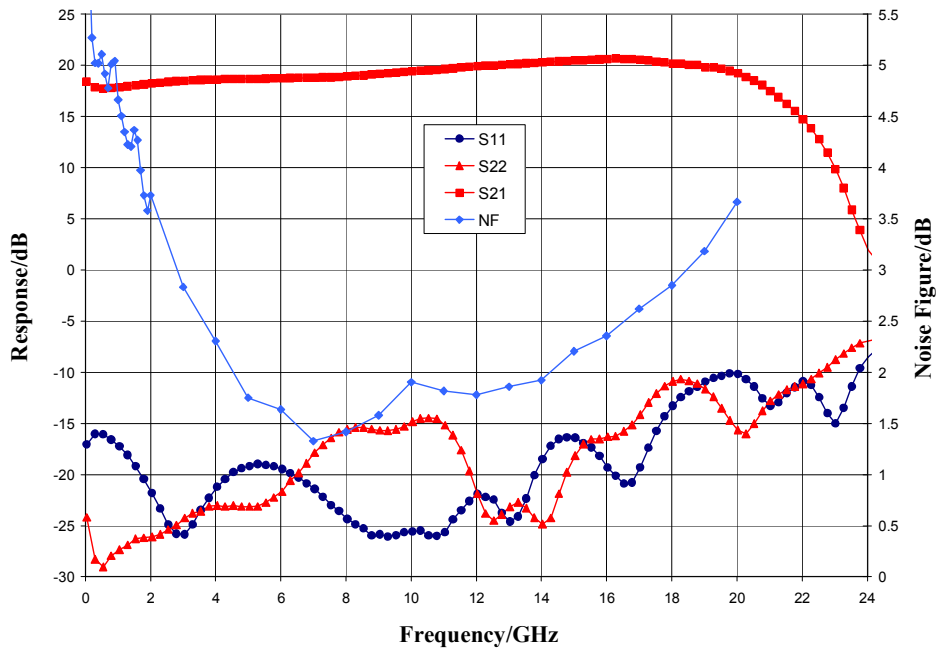

**Narrow-band Performance,  $V_{dd} = 8.0$  V,  $V_{gg} = -1.0$  V,  $I_{dd} = 170$  mA,  $T_A = 25$  °C**

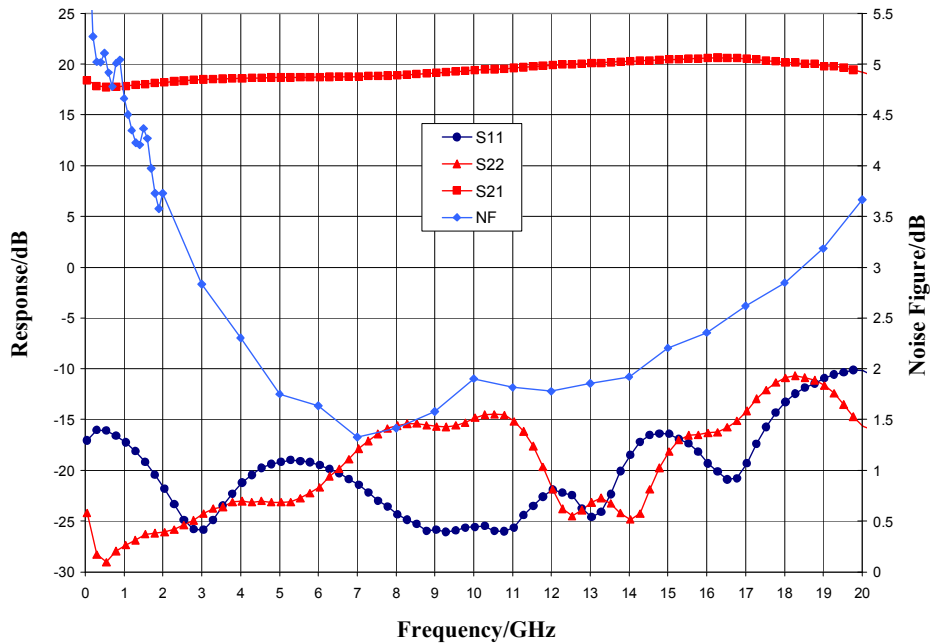

ver 2.1 1214

### Typical Performance

**Gain vs. Temperature,  $V_{dd} = 8.0\text{ V}$ ,  $V_{gg} = -1.0\text{ V}$**

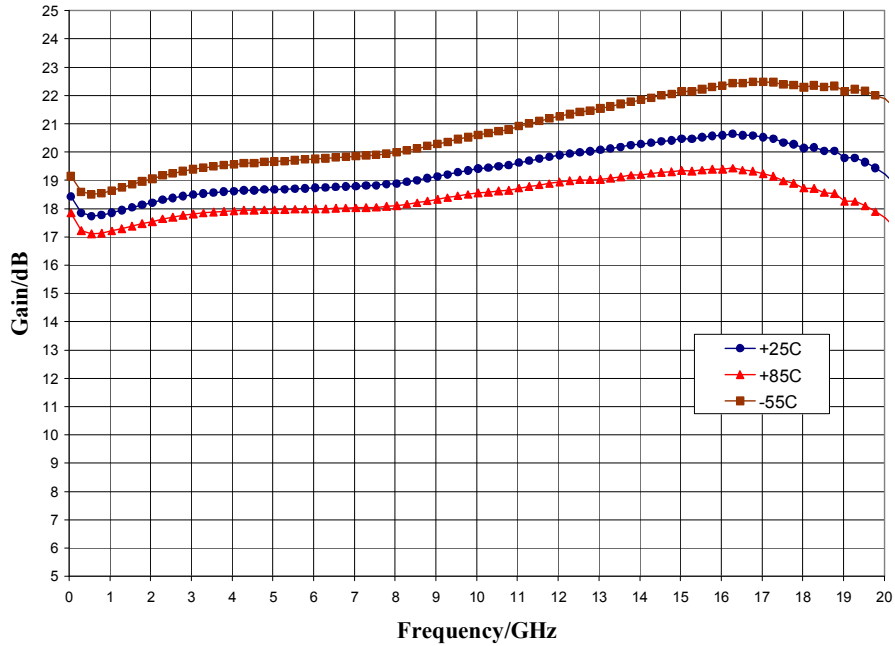

**Noise Figure vs. Temperature,  $V_{dd} = 8.0\text{ V}$ ,  $V_{gg} = -1.0\text{ V}$**

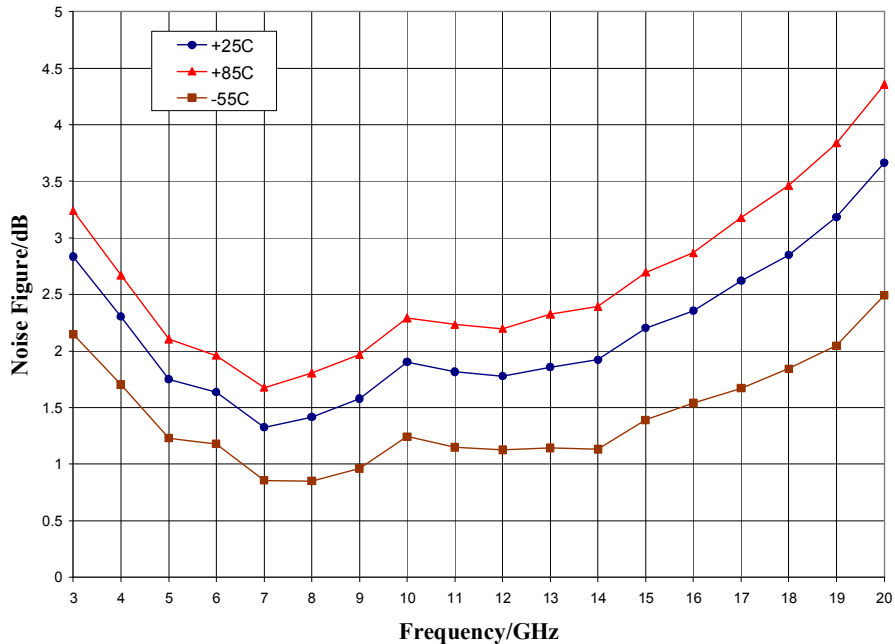

ver 2.1 1214

### Typical Performance

Output Power,  $V_{dd} = 8.0\text{ V}$ ,  $V_{gg} = -1.0\text{ V}$ ,  $T_A = 25\text{ }^\circ\text{C}$

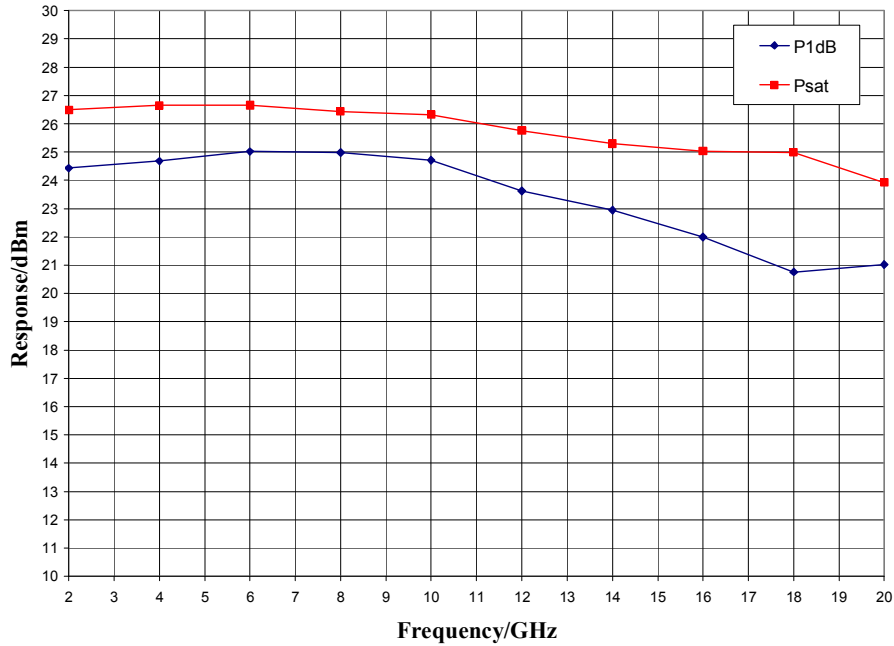

P1dB vs. Temperature,  $V_{dd} = 8.0\text{ V}$ ,  $V_{gg} = -1.0\text{ V}$

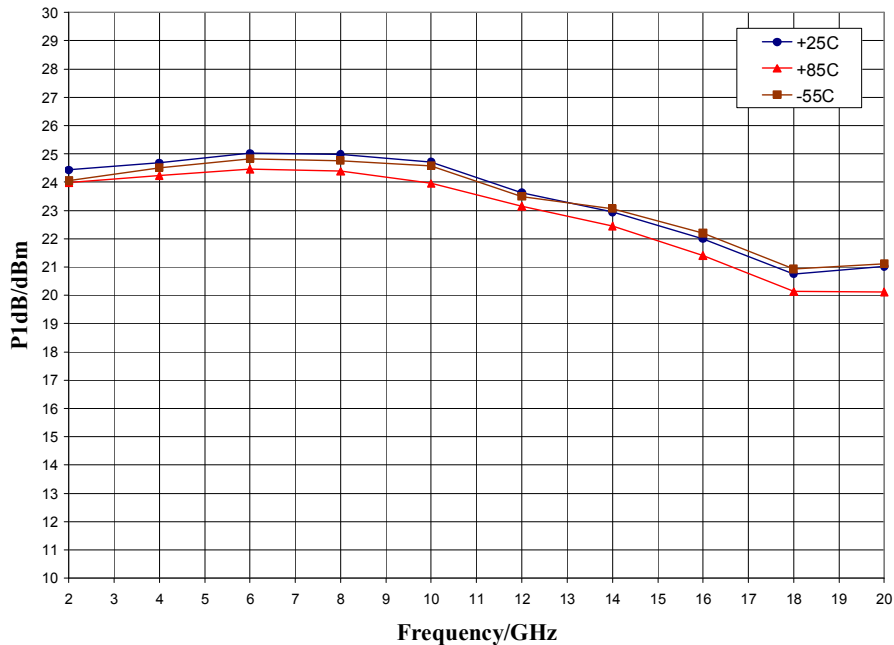

ver 2.1 1214

### Typical Performance

Output IP3 vs. Temperature,  $V_{dd} = 8.0\text{ V}$ ,  $V_{gg} = -1.0\text{ V}$

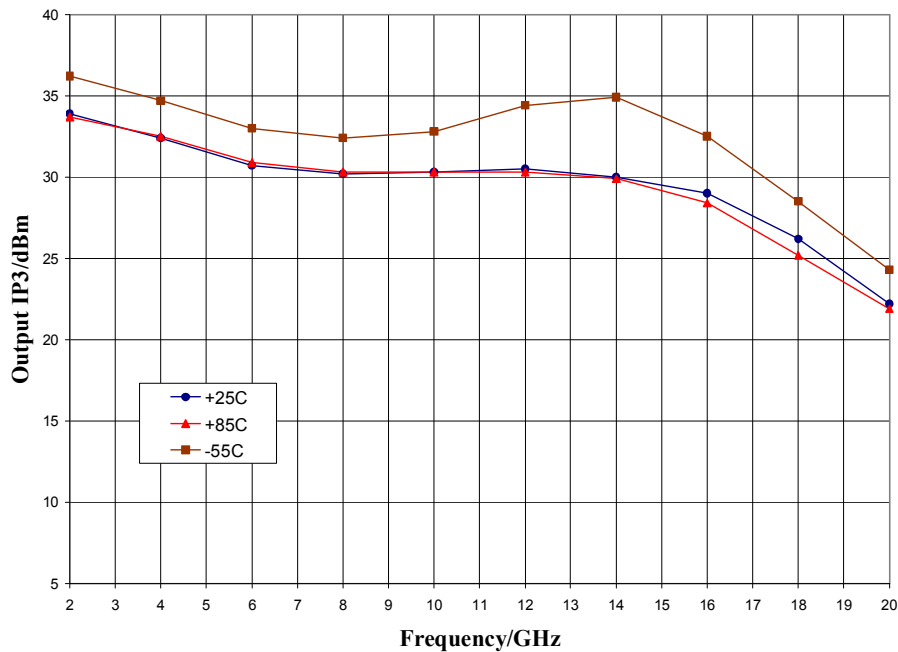

### Mechanical Information

#### Die Outline (all dimensions in microns)

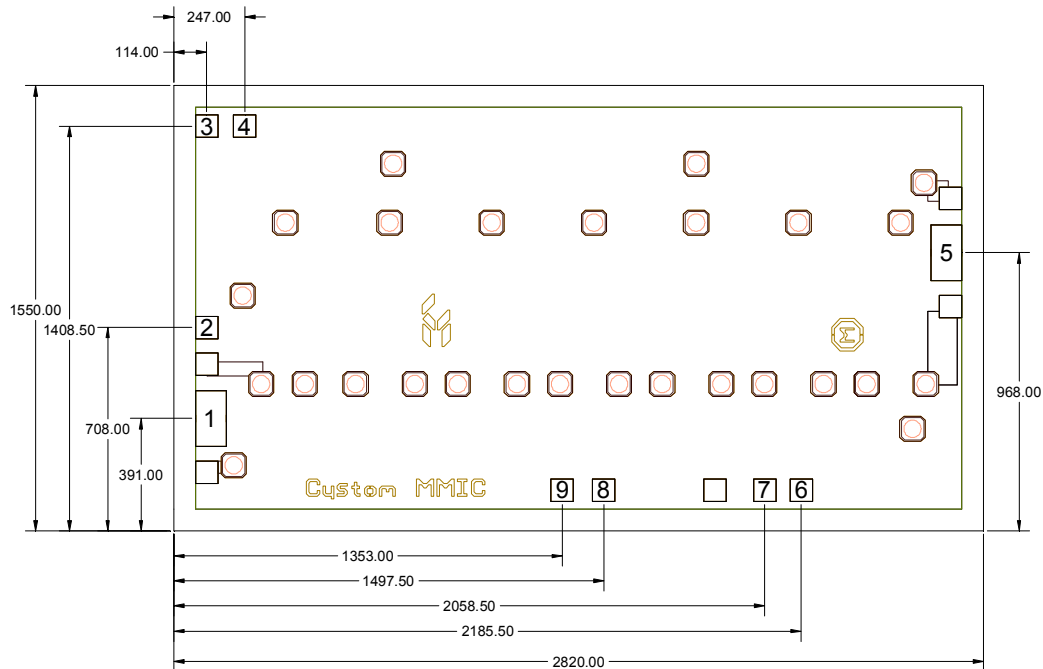

#### Notes:



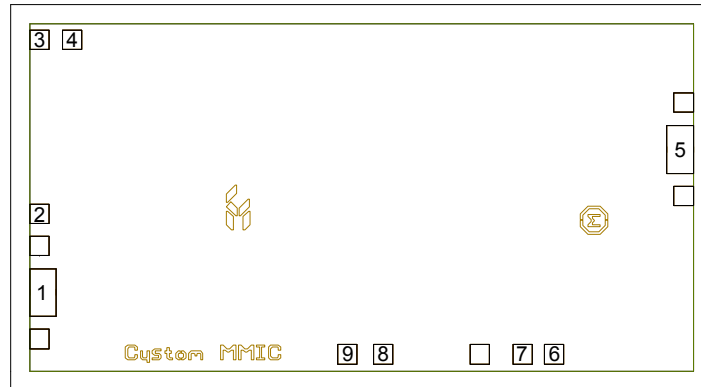

1. No connection required for unlabeled pads
2. Backside is RF and DC ground
3. Backside and bond pad metal: Gold
4. Die is 85 microns thick
5. DC bond pads are 100 microns square

### Pad Description

### Pad Diagram

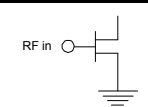
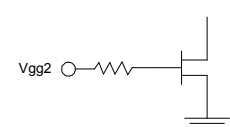
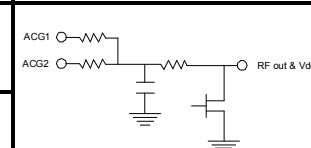
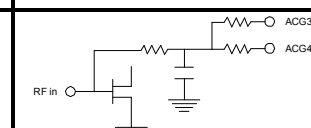

### Functional Description

Pad	Function	Description	Schematic
1	RF in	50 ohm matched input	
2	Vgg2	Optional supply voltage for gain control Decoupling and bypass caps required	
3, 4	ACG1, 2	Low frequency termination. Attach bypass capacitor per application circuit	
5	RF out & Vdd	Power supply voltage and 50 ohm matched output	
6, 7	ACG3, 4	Low frequency termination. Attach bypass capacitor per application circuit	
8	GB	Connect to DC ground	
9	Vgg	Power supply voltage Decoupling and bypass caps required	
Backside	Ground	Connect to RF / DC ground	

ver 2.1 1214



### Applications Information

#### Assembly Guidelines

The backside of the CMD192 is RF ground. Die attach should be accomplished with electrically and thermally conductive epoxy only. Eutectic attach is not recommended. Standard assembly procedures should be followed for high frequency devices. The top surface of the semiconductor should be made planar to the adjacent RF transmission lines, and the RF decoupling capacitors placed in close proximity to the DC connections on chip.

RF connections should be made as short as possible to reduce the inductive effect of the bond wire. Use of a 0.8 mil thermosonic wedge bonding is highly recommended as the loop height will be minimized. The RF input and output require a double bond wire as shown.

The semiconductor is 85 um thick and should be handled by the sides of the die or with a custom collet. Do not make contact directly with the die surface as this will damage the monolithic circuitry. Handle with care.

#### Assembly Diagram

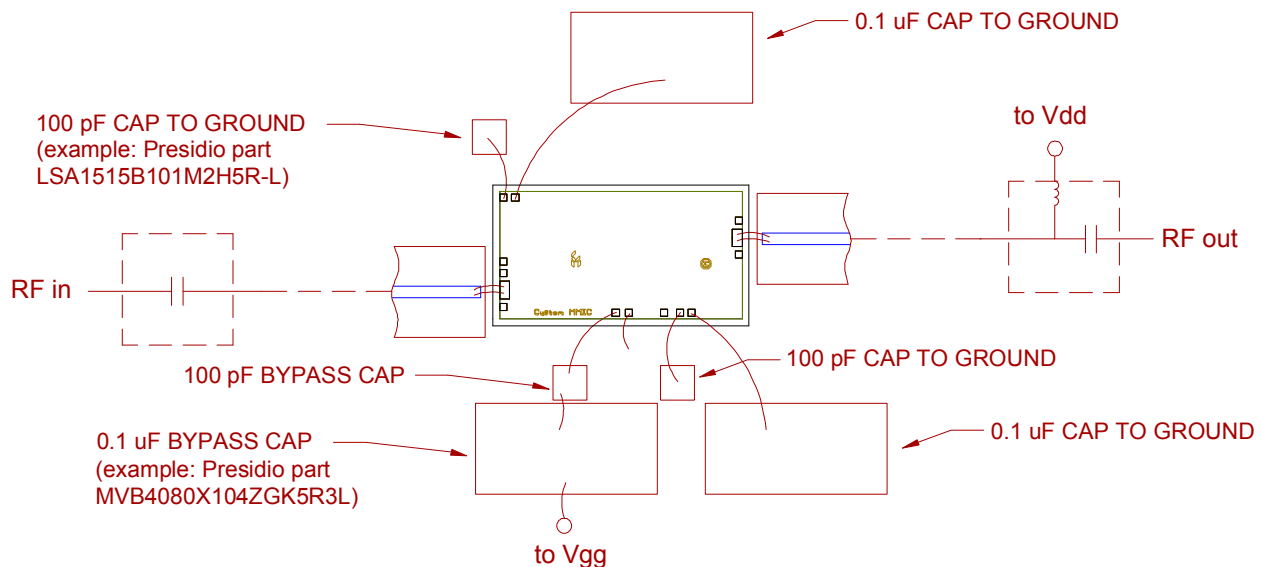

**GaAs MMIC devices are susceptible to damage from Electrostatic Discharge. Proper precautions should be observed during handling, assembly and test.**

### Applications Information

#### Application Circuit

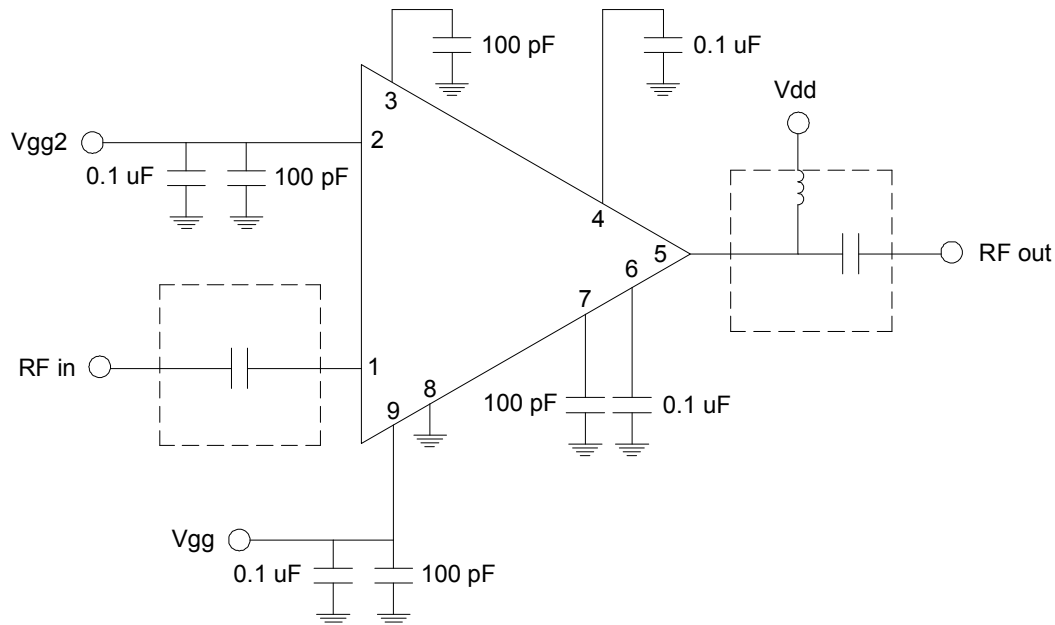

Note: Drain voltage ( $V_{dd}$ ) must be applied through a broadband bias tee or external bias network. External DC block is required on RF input.

#### Biasing and Operation

The CMD192 is biased with a positive drain supply and negative gate supply. Performance is optimized when the drain voltage is set to +8.0 V. The recommended gate voltage is -1.0 V.

Turn ON procedure:

1. Apply gate voltage  $V_{gg}$  and set to -1 V
2. Apply drain voltage  $V_{dd}$  and set to +8 V

Turn OFF procedure:

1. Turn off drain voltage  $V_{dd}$
2. Turn off gate voltage  $V_{gg}$

RF power can be applied at any time.